

HeatWorks

HeatWorks 13 | February 2015 | www.ceramicx.com

THERMOCOUPLES

understanding
thermocouple issues

INTRODUCING THE
Cerix-NG

THERMOFORMERS

Time to
switch to Infrared

'THE HERSCHEL'

Engineers develop
infrared detector to
map the invisible

TRAINING

Benefit from Infrared
Heating Knowledge

40% ENERGY SAVING

.....thermoformers can
make **immediate
savings** on energy
and energy cost



Gandhinagar | Gujrat | India
PLASTINDIA



Istanbul | Turkey
CERAMICX TURKEY



Orlando | Florida | USA
NPE2015

The power of two

Firstly, may I wish all our readers a very Happy and Prosperous New Year for 2015. Our last HeatWorks magazine recorded a series of notable 'firsts' and this, our thirteenth edition, goes on to present a number of interesting doubles .

For example, we are pleased to publish two in-depth technical articles in these pages. The first feature records our ground-breaking and patented work in the thermocouple arena. The second explores a study, commissioned by Ceramicx, on the energy saving consequences of a Ceramicx IR heatwork upgrade on an inline thermoforming machine for a client, comparing performance to an identical client production line. I am delighted to note that our work now saves our client some 40% of its energy cost.

Secondly, we record the Ceramicx participation in two very important upcoming shows for Q1 2015; Plastindia, Feb 5-10 in Gujrat, NPE 2015 in Orlando, Florida, USA. Both will warrant extensive reporting and review coverage in Q2 later this year.

We also report on our newly agreed licencing partnership with Trinity College Dublin, thereby opening up the market for increased production and sales of our Herschel IR measurement machine tool; an instrument that is set to further reveal the world of IR heat for all.

Partnership, as I am fond of relating, is one of the key building blocks in today's business world. I continue to invite our readers to take the opportunity to partner with us in communicating all the features and benefits of Infrared Heating for Industry. We are always interested in your expertise and experience and we look forward to hearing from you at all times.



Frank Wilson
Managing Director, Ceramicx Ltd.

HeatWorks

Publication manager	Cáthál Wilson	cathal.wilson@ceramicx.co.uk
Editorial	Adrian Lunney	adrian@adrianlunneypr.com
Design and Production	David Hayward	david.hayward@ceramicx.com
Distribution	Amanda Murphy	amanda.murphy@ceramicx.com
Published by	Ceramicx Ltd.	sales@ceramicx.com

Contents

Page 1 Thermocouples -

Thermocouple design and placement in a ceramic element.

Page 5 The Herschel -

An IR (Infrared) test instrument for the international market.

Page 6 Massive Energy Saving -

Ceramicx has just confirmed 40% energy savings for a thermoforming customer's infrared heating system.

Page 8 Time to Switch -

The benefits of thermoforming with Infrared.

Page 10 Plastindia 2015 -

The 9th International Plastics Exhibition and Conference comes from a recently built exhibition centre in Gandhinagar, Gujra, India.

Page 11 Plastics in India -

With a working population of 467 million people we look at the expansion of the plastics industry.

Page 12 NPE 2015 -

Ceramicx and Weco join forces for the International Plastics Showcase in Orlando, Florida, USA

Page 13 Materials testing -

'Dry run' your materials with this Long, medium and short wave infrared test oven.

Page 14 Weco's varied portfolio

Page 15 Ceramicx Turkey -

Will this year be established in the Istanbul industrial area under the management of Hasan Duman.

Page 16 Infrared training -

Online training course on industrial infrared heating

Page 17 Clamshell oven -

Combined radiant/convective 12.1kW Clamshell oven

Page 18 Ceramicx Product Range

Page 24 Ceramicx News

Page 24 -29 The Ceramicx Team

Talk to us today about your infrared needs

Thermocouples – unpacking the issues - and breaking the mould

By Frank Wilson, Dr. Gerard McGranaghan, Tadhg Whooley, and Padraig Courtney

Ceramicx has invested considerable time and talent in the thermocouple field, advancing and protecting its patented work in this area. The company has also put together an extensive technical report of its understanding of thermocouple issues as they apply to heat work and IR heat work. HeatWorks reports here on the main findings of that work. A full account of that will be presented in a White Paper, which will be published on the Ceramicx website in late February 2015.

Ceramicx has analysed the leading thermocouple types on the market today; researched issues in their usage, and has invested in its own patented thermocouple technology and innovations.

It is well documented that thermocouple performance in the context of IR radiation and heatwork can be a source of confusion for the general industrial user. And although thermocouple measurement is a reasonable indication of applied radiation, mapping the thermal dynamics of a complete IR heating system must incorporate many other elements.

This HeatWorks article will accordingly set out both the Infrared Heating context and background and will present some of the leading thermocouple designs and innovations that Ceramicx has pioneered and is now manufacturing.

The Thermocouple in a Ceramic Element

Thermocouples are fitted within ceramic elements in order to give a practical temperature signal either for operator indication or for feedback in control systems. The thermocouples are placed so as to give an indication of the front face temperature of the ceramic element

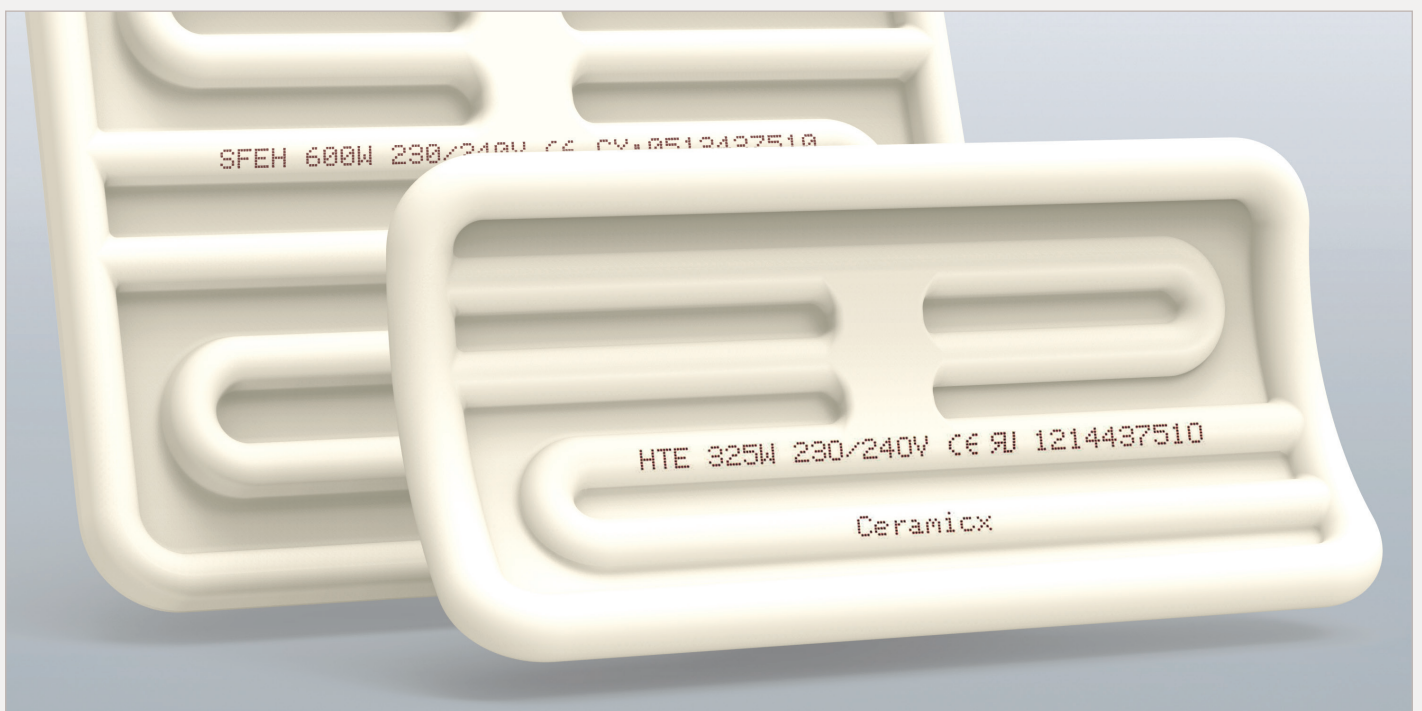

The new thermocouple location in the rectangular section running across the ribs brings the thermocouple closer to the surface of the element, while maintaining its interaction with the resistance coil.

itself and yet near to the heating coil so as to provide a satisfactory thermal response. While the fitment and use of a thermocouple is undoubtedly necessary for closed loop feedback systems, there are many factors which must be understood and taken into account in order to derive the optimum benefit from the thermocouple.

These include factors such as

- thermocouple type
- material limitations
- supplier variations
- methods of joining
- thermocouple design and location

In addition, the thermocouple is an intrinsic part of the manufacture of the element. Processes include

- Wet placement and casting
- Firing operations
- Beading and terminations
- Testing methods

Therefore a thermocouple placed within a ceramic element must be able to tolerate all of the above manufacturing processes and still provide a robust output at the end of manufacture.

In the fifth and final design, the thermocouple leads make contact with the quartz tube via the twin tube and are then passed around the back of the tube where the welded junction is placed. The two remaining ends are then wrapped around and tied. This wrap around construction provided optimum thermal exposure to the heating coil.

The completed thermocouple assemblies were threaded on to a 1000W coil and placed within a test assembly. The tubes were then filled with white cement to simulate a ceramic slip which was allowed to cure in air before testing. The results of the tests are visible in Figure 3b here. The rate of temperature increase between all thermocouples are directly compared, with each new design showing an improvement over the current Cerix. The fastest reacting thermocouple is Type 5, the wrap around design, with a heat up rate of 12°C per second.

This responds almost 4 times faster than a conventional triple wound and welded thermocouple. This is expected to produce a faster response than the current triple welded type when put in to production. With the placement of the thermocouple in the rib, and with the improved design and response, the new Ceramicx Cerix NG thermocouple will perform to the highest levels in terms of accuracy, response speed and longevity.

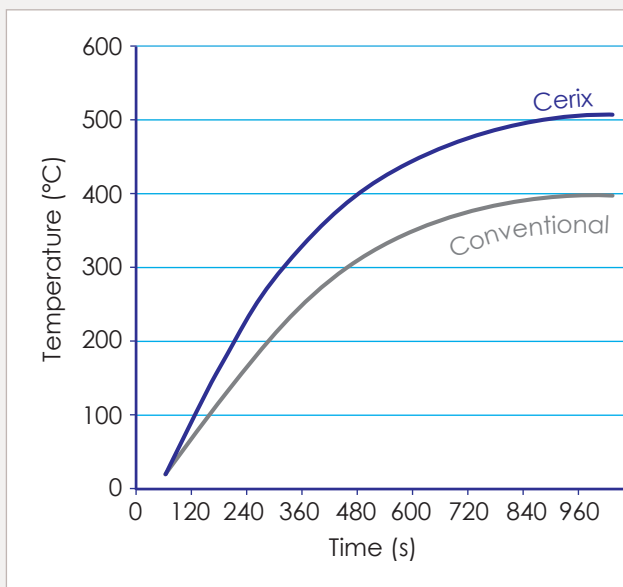

Figure 3a
Old Cerix response versus conventional thermocouple

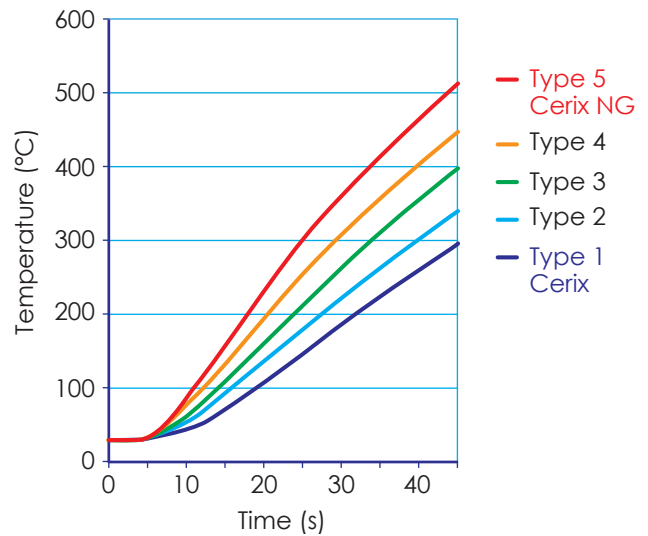

Figure 3b
Lab test comparing old Cerix (blue) with other thermocouple designs including improved new generation Cerix NG

Introducing the thermocouple Cerix NG

Ceramicx designs and manufactures its own thermocouples and the current model is named Cerix. In creating the Next Generation (NG) Cerix thermocouple, Ceramicx examined four possible new designs of thermocouple before settling on the Cerix NG

The first type of thermocouple is the current Cerix design, where two strands of triple wound thermocouple wire are spot-welded on top of each other to form the thermocouple junction. After the spot weld is made, two excess strands are trimmed, and the remaining single strands of each leg are then tied around a quartz glass tube to fix the thermocouple in relation to the heating coil. Variations on this formed the other designs which comprised the second, third and fourth designs.

The Cerix NG thermocouple is now being introduced to the market and will be readily integrable with all production and control systems.

Ceramicx has found it necessary to introduce a better product to the market since tests on various models had revealed a number of possible deficiencies in the IR heating context. For example:

- The ceramic pillar can often act as a heat sink causing slow response in thermocouples
- An improved thermocouple response can be given by re-positioning the thermocouple junction inside a rib section away from the pillar.
- The design of the measuring bead (hot junction) has a major effect on the thermal response.

These factors were all borne in mind when considering the designs for the Ceramicx Cerix NG thermocouple.

Many other factors were also considered in the design and manufacture of the Cerix NG, including placement in element; thermal and kiln firing effects; thermocouple signal outputs; issues of electrical noise; terminations and connections; thermocouples and heat flux outputs. Highlights of the upcoming White Paper are summarized in the following:

Thermocouple Design – placement in element

This issue is critical, and Ceramicx has a patented process which addresses the problems of consistent location, electrical noise, and repeatable temperature output via the patented Cerix Thermocouple. The advantages of this Cerix system will be retained and improved in the new Cerix NG (Next Generation) thermocouple.

This process operates on the principle that clear quartz glass is an excellent transmitter of infrared radiation, an efficient and rapid means of transferring heat into an object.

By placing a clear quartz tube over the heating wire and by keeping the thermocouple in direct contact with the tube, heat from the wire coil is rapidly transferred into the thermocouple. Temperature changes in the element are therefore now very closely tracked. The Cerix system also prevents displacement of the thermocouple during the casting process. Figure 4 shows the location of the Cerix thermocouple within the element.

As quartz glass is a good electrical insulator, electrical interference between the heating wire and the thermocouple is minimised. The uniform diameter of the quartz tube ensures the distance between the thermocouple and the heating wire is maintained constant for all elements. This in turn leads to consistency in the thermocouple readings of the ceramic elements. The Cerix thermocouple also gives an enhanced response time compared to previous systems as can be seen in Figure 3a which shows the difference between a conventional potted type K thermocouple and the Cerix type K thermocouple.

A further advantage of the Cerix thermocouple construction is that it permits high heat transfer to the thermocouple tip via infrared means, not primarily via conductive means. This allows extra thermal sensitivity without increasing the amount of metal in the thermocouple tip which can lead to increased electrical interference.

Thermocouple placement always requires a compromise in location - so that the thermocouple is close enough to the heating coil for a fast response, yet at enough distance from the coil so as not to pick up excessive electrical noise. The thermocouple must also perform repeatably so that the final indicated temperature is related to the actual temperature of the front face of the heating element.

Wire quality; degradation and lifetime service

Thermocouple weakening can be caused by poor production or quality control by the wire supplier. If the roughness's and tearings in the supplied wire are significant they can cause cracking after kiln firing as any tears or surface defects are ideal points for crack initiation.

Ceramicx's kiln expertise makes the company uniquely placed to also research and test thermal effects of wire quality.

Ceramicx has found that embrittlement of thermocouple wire can occur in service and the company has performed

extensive testing to overcome potential problems in this area. A type K thermocouple, for example, typically comprises two legs, one positive made from Chromel, the other negative made from Alumel. Despite the Type K being suitable for use up to 1260°C in oxidising and inert atmospheres, over time both Chromel and Alumel can deteriorate.

A form of deterioration in the Chromel leg is well known and manifests as "green rot" where the oxygen preferentially combines with the chromium in the material. However this degradation is more diffusion based and is therefore dependent on time and temperature.

In the Alumel leg the nature of the failures is normally brittle fracture where the wire fails suddenly. The failure is characterised by a locally very brittle area. Large grains approaching the size of the wire diameter within the metal strands which lead to brittleness and increase the likelihood

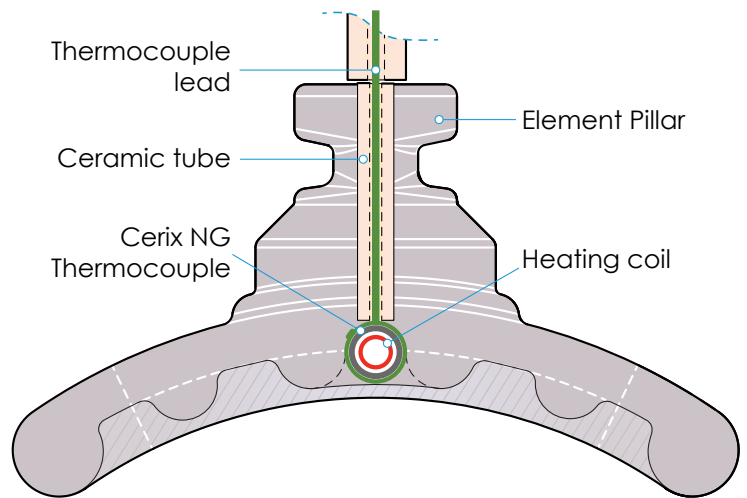

Figure 4

of cracking of the wire. The time scale of this deterioration is more unpredictable in nature.

The amount of oxide and scale produced during kiln firing can differ greatly between different wire suppliers and kiln firing will also affect the tensile strength of K-type Thermocouples. A Ceramicx programme of tests was undertaken to evaluate the degradation suffered by thermocouple wire after repeated kiln firing. Several types of wire from different manufacturers were investigated for trial across several temperatures. Samples of wire were cut into lengths of 150mm and then fired. The wire samples were then tested for breaking strength and showed surprising variability between manufacturers of even basic K type thermocouple wire. (The full results of this research will be available in the upcoming Ceramicx White Paper)

These experimental results on the changes in thermocouple wires caused by the harsh environments constitute a vital part of Ceramicx's development and product reliability.

Thermocouple signal output

A range of issues can affect thermocouples and therefore the thermocouple signal output. Poor bead construction of the actual thermocouple tip can affect the readings if the material characteristics are changed because of excessive weld temperature. Also an excessively large weld bead

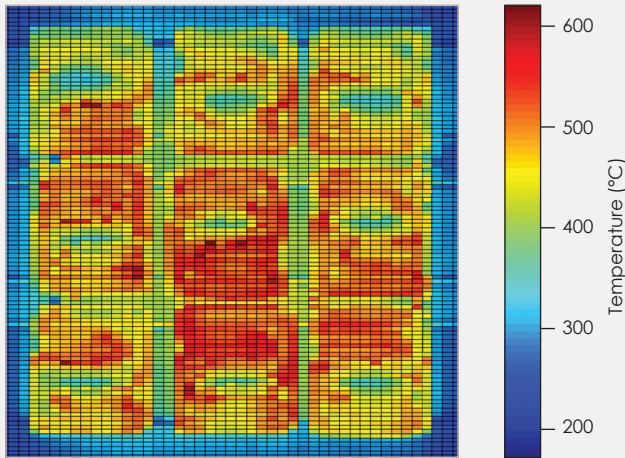

Figure 5a - Temperature (°C) scans from our non-contact IR thermocouple without reflector. All elements on.

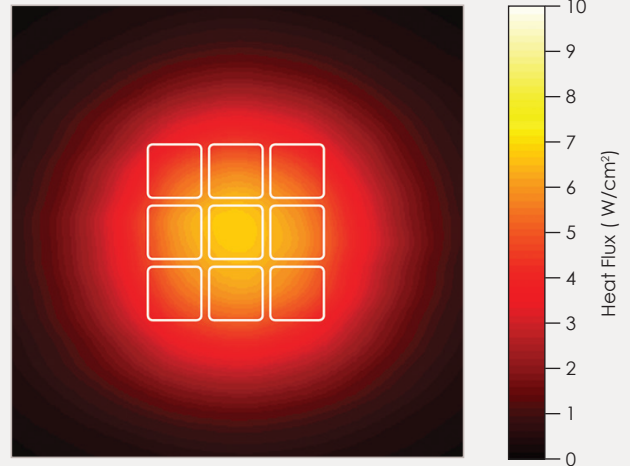

Figure 5b - Despite the difference in surface temperature seen in fig 5a the Heat Flux (W/cm²) profile at 100mm does not show the same variation .

will cause a temperature gradient across it affecting the measuring zone.

An electrical connection of high integrity is an essential pre-requisite in any thermocouple installation. As a pre-emptive measure Ceramicx offers high strength crimped connections in either bootlace ferrule or ring terminals. Ceramicx also spot-welds the thermocouple wire to the ring terminal as a secondary and precautionary measure. Bootlace ferrules are normally held in a screw terminal which exerts sufficient pressure to ensure a good electrical contact.

Heat can also conduct along the thermocouple sheath or wire, thus changing the local bead temperature, and therefore the indicated temperature. Therefore a small diameter thermocouple will conduct less heat and provide a more accurate result. Careful positioning of the thermocouple is also important as already noted.

To check for variations in the actual temperature output of Type-K thermocouples before and after kiln firing some trials were recently conducted at Ceramicx on two separate batches of pre-manufactured thermocouples from a leading supplier. In addition, tests were carried out on thermocouples made from the same supplier wire but manufactured in house using Ceramicx equipment. Variations were again noticed in relation to wire type and temperature of exposure. (Again, these study findings will be published in the full Ceramicx White Paper)

Electrical Noise and Leakage

This is a key issue. Ceramic elements from all manufacturers can in some cases suffer from electrical feedback through the thermocouple connections, sometimes causing problems with customer control systems.

Noise prevention is important as stray magnetic fields (from power cables and other electrical equipment) can be picked up by the fine thermocouple leads and extension cable and can be misread as part of the thermocouple signal. These magnetic fields create additional voltages within the thermocouple wires and extension cables. As thermocouples produce such tiny voltages to begin with (a type K produces around 0.203mV between 25°C and 30°C) any electromagnetic interference picked up by the wires can easily generate voltages of the same magnitude or larger. Noise can be either temporary or constant depending on its source.

In a range of experiments carried out by Ceramicx, various solutions to overcome these problems including thermocouple design, firing temperature and ceramic formulation were trialled. A combination of factors was found that led to a reduction in the electrical conductivity of the element. These factors and designs are present in the manufacture of the new Cerix NG thermocouple and ceramic elements.

Thermocouple and Heat Flux outputs

It must be remembered that a thermocouple is installed in order to assist in the control of the temperature of the element. It does not refer to the processing temperature of the target material, but to the internal temperature of the element. Any input power to the element will result in an increase in element temperature and hence in radiative heat flux based on its overall emissivity. Processing conditions and many other factors can also have an effect on the element temperature therefore it is difficult to provide complete guidance on the final application.

In a ceramic element, the consistency in the positioning of the coil and the high emissivity of the ceramic material means that a high proportion of the heat generated from the coil will be emitted as infrared energy. Temperature variations occur across the face of the ceramic element, both between the rib and trough where the differences can be up to 30°C, and in the region of the pillar which constitutes a relatively cold zone of the face. Despite these variations in surface temperature, the profile and amount of infrared radiation emitted is largely unaffected. This is shown in the following image in Figure 5 where the front face of an array of QFE elements is shown.

The temperature field shows large variations even down to delineating the gaps between elements. However, when used in industry at typical distances (75-200mm), small variations in heater surface temperature do not have a significant effect on the heat flux field, and therefore do not have a significant effect on the immediate temperature of the target material.

Ceramicx Cerix NG thermocouple products are fitted to a wide variety of the company's current products and are available to purchase. To obtain the Ceramicx White Paper – Thermocouples on publication – please email Dr Gerard McGranaghan at Ceramicx. Gerard.McGranaghan@ceramicx.com ■

IR heat enlightenment for the world -

Ceramicx and TCD provide with EI support



Ceramicx Ltd and Trinity College Dublin (TCD) have both signed a licensing agreement that will enable Ceramicx to utilise IP (intellectual Property) generated through an innovation partnership to manufacture an IR (Infrared) test instrument for the international market.

The new deal carries far-reaching implications for international manufacturing and for industry. The applied science of Infrared heating is still in a relative infancy. IR heating is commonly misunderstood and often misapplied in manufacturing.

Now for the first time, the Herschel will allow users and heat-work practitioners

are combined to provide the most practical ways in measuring radiant heat flux distribution from any given heater system. From that base criteria the system can be tweaked to measure different effects; effects on target bodies such as plastics for example; effects of different heater and reflector design and the effects of

Mr. Frank Wilson,
Managing Director, Ceramicx.,
Dr. Graham McMullin,
Technology Transfer Case Office,
Trinity College Dublin.

Dr. Graham McMullin,
Technology Transfer Case Office,
Trinity College Dublin.,
Dr. Gerard McGranaghan,
Senior Development Manager, Ceramicx.,
Prof. Anthony Robinson,
Principle Investigator, Trinity.,
Mr. Declan McGee,
Innovation Partnership Programme
Manager, Enterprise Ireland.



The agreement represents the fruit and flowering of an Innovation Partnership (IP), part funded by Enterprise Ireland. The first such machine resulting from the IP was christened The Herschel, after the nineteenth century discoverer of the Infrared spectrum.

The first Herschel was constructed in the Summer of 2013 at TCD's Research facility in Dublin under the direction of Professor Tony Robinson and his team. It then made its international debut under the Ceramicx banner in October 2013 at the K triennial plastics exhibition, Düsseldorf, Germany; an event that drew some 219,000 visitors.

A consequent groundswell of interest and support from the international manufacturing community encouraged both TCD and Ceramicx to plan the sales and marketing of further Herschels for an international user base. The new licensing agreement formalises these plans and fires the starting pistol for a programme of international marketing and sales.

to create a full package of 3D data that makes a visible and predictive science in an area that was effectively guesswork – and invisible.

The benefits will be immeasurable.

Frank Wilson, Ceramicx founder and Managing Director says that 'Infrared heat radiation has sometimes been described as 'sunshine without light'. Our new machine tool now provides a way to measure and map that previously invisible spectrum of energy. It can therefore enable users to precisely plan their manufacturing, save cost and waste, and also gain a greater understanding and measurement of how IR elements and all target materials actually perform. The benefits will be immeasurable.'

The new machine design is a world-first. Sensors, robotics; thermocouples, and sophisticated analysis software

different kinds of IR heat; such as short, medium and long wave.

Ceramicx Ltd has been perfecting and honing its IR heat work trade for the past twenty five years and the new IR instruments will enjoy instant access to the Ceramicx global sales network. The company has distributors in all continents of the world and currently exports 98% of its IR heating production to over 62 countries.

Frank Wilson says that 'we specialise in infrared heat uses and process heat transfer. Throughout the company lifetime we have been perfecting the price/performance ratio for infrared technology – and also thereby lowering the carbon footprint for our customers/users. The new Herschel will add yet more resources for these customers and for the worldwide heating industry generally.' ■

Massive energy-saving breakthrough for inline thermoformers

Ceramicx has just confirmed 40% energy savings for a thermoforming customer's infrared heating system when compared to a conventional heating system on an identical thermoforming machine.

We report here on an independent study, commissioned by Ceramicx and conducted by Dr. Robin Kent of Tangram Technology Ltd – Consulting Engineers for Plastics Products that measured the detailed differences between the two plastic thermoforming systems.



Direct comparisons between two thermoforming lines at the customers were undertaken using identical tools, products and cycle times. The measuring equipment used for all electrical testing was the Elcomponent SPC Pro. This is a device that measures all three-phases of the complete incoming supply to the thermoforming machine. It uses a single phase supply (phase to neutral) as a reference voltage for the calculations.

The Ceramicx based heating systems showed a decrease in the average power drawn from 56.16 kW to 32.85 kW, representing a 41.6% reduction. Figures were also taken that showed a direct comparison between the two oven systems. With the machine base

loads removed, the Ceramicx system then showed a measured energy saving of 45.8%. Additional study work undertaken showed that yet further improvements and energy savings would be available using the new Ceramicx-based system. (Please see Table 1 and Table 2 for more data)

Both machines were directly comparable and both are part of two

in-line and fast cycling systems at the customer, loaded with the same tools both making the same polystyrene-based products for the Fast Moving Consumer Goods (FMCG) and food service markets.

The Ceramicx IR-based oven platen and control system was designed and built at the company's manufacturing facility in West Cork, Ireland before

Table 1

	Current 1 (amps)	Current 2 (amps)	Current 3 (amps)	Power (kW)
Thermoforming Machine 1 Calrod System	84.5	82.0	90.3	56.2
Thermoforming Machine 2 Ceramicx System	53.8	53.2	63.3	32.8
Reduction in phase current	30.7	28.8	27.0	23.4
	Saving (%)			41.6

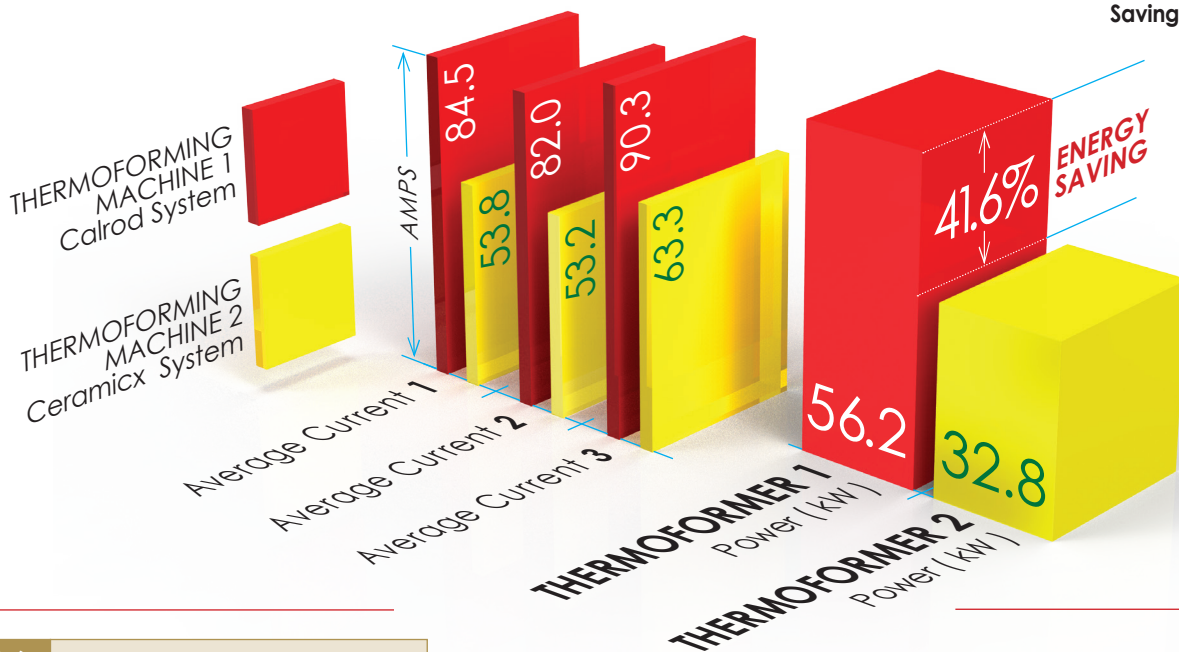

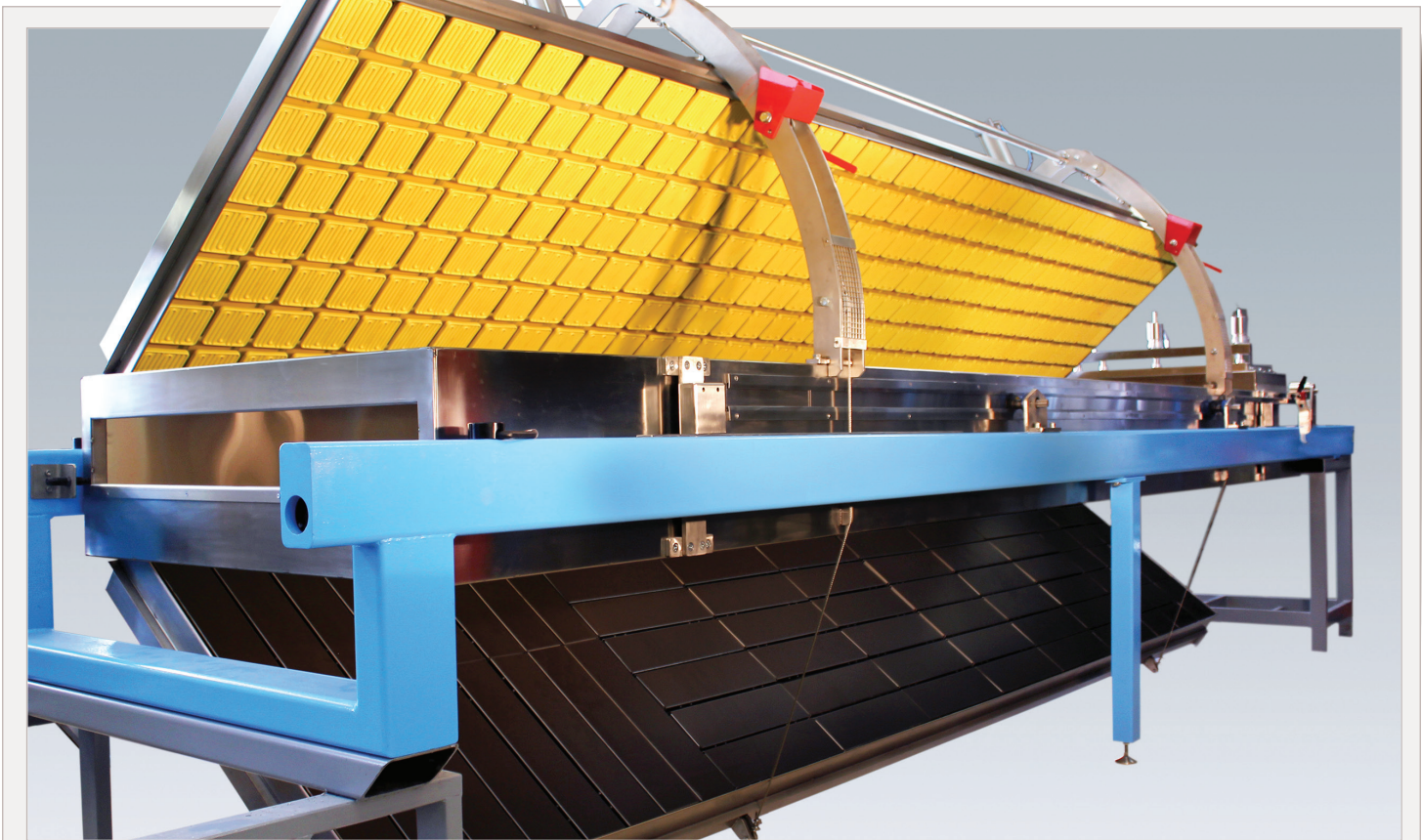

A 160kW retrofit oven designed and manufactured by Ceramicx

being shipped directly to the customer's manufacturing facility. The Ceramicx oven has a total of eight temperature sensors built into the system. These can be selected individually or grouped for control purposes. Additionally the heaters can be subdivided into as many as 132 separate zones, thus giving a wide range of control options.

The Ceramicx oven system features upper and lower heating platens together with power control systems, enclosures, switchgear, and PLC control.

A total of 420 World Class rated Ceramicx IR elements were deployed in this particular oven system. Each of these Ceramicx-made elements has its own unique and traceable heating fingerprint, the performance of which is documented and verifiable online. World Class Manufacturing is determined as part of the Benchmarking Competitiveness Initiative across companies globally, and is administered by Enterprise Ireland in Ireland, World class refers to being in the 90th Percentile of Companies of a similar size and industry focus.

The oven assembly itself is fitted with pneumatic cylinders which are operated manually via two solenoid valves. The lower platen is used as a counterweight, using steel rope and pulleys. The control systems offer the processor a choice of both open and

closed loop control, together with cost-saving procedures in start-up and fault monitoring in addition to inline process energy control.

.....thermoformers can make immediate savings on energy and energy cost

Ceramicx founder and Managing Director Frank Wilson says, "We are very pleased indeed to confirm through a programme of scientific study and measurement what we have always intuitively known - that Ceramicx-built IR heat solutions give fantastic and immediate savings for fast-cycling thermoformers."

Brett Wehner, CEO of Ceramicx's USA distributor, Weco International, says, "What's exciting about this work is that it shows how fast-cycling thermoformers can make immediate savings on energy and energy cost in addition to the quality components produced. Not only that, their packaging can legitimately claim to be 40% greener,

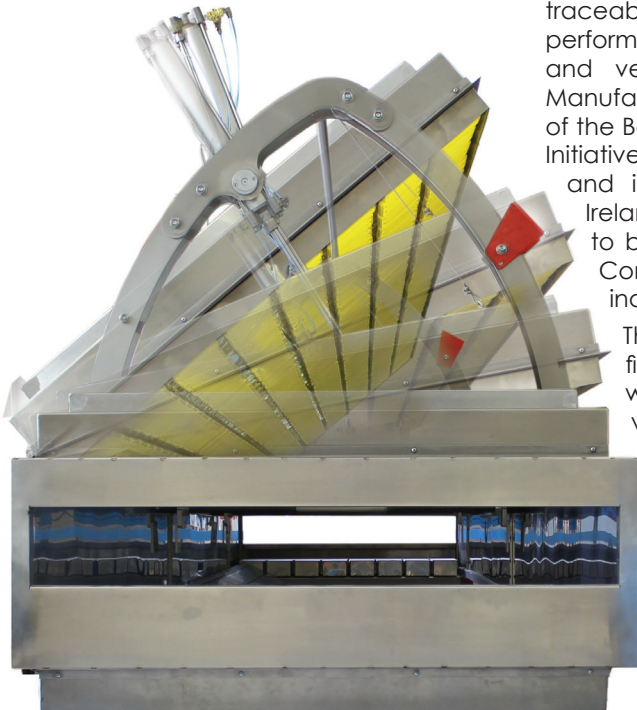

with a de facto 40% reduced carbon footprint. It really is win-win for the thermoformer.'

Ceramicx has been building IR heat solutions for thermoformers for over 20 years. And since 2011 Ceramicx has been rated as a world class manufacturer and supplier of IR based heating solutions including components, ovens and platens for the worldwide thermoforming industries. During the past 4 years Ceramicx has developed unrivalled expertise for cost-saving in-line thermoforming heat solutions and IR-based retrofits.

Weco/Ceramicx will be adding to and developing these energy saving messages in the coming months as part of their joint preparations for the USA's triennial plastics exhibition,

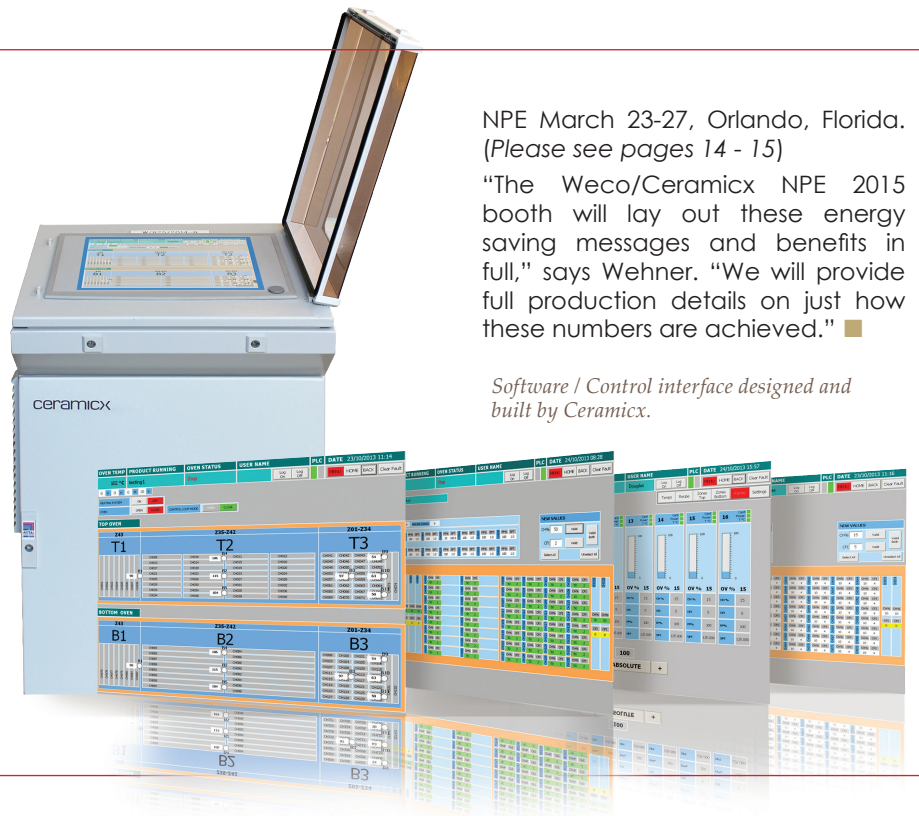

NPE March 23-27, Orlando, Florida.
(Please see pages 14 - 15)

"The Weco/Ceramicx NPE 2015 booth will lay out these energy saving messages and benefits in full," says Wehner. "We will provide full production details on just how these numbers are achieved." ■

Software / Control interface designed and built by Ceramicx.

Time for all Thermoformers to switch to IR methods.

'The best thermoformers in the world always make sure to question and re-evaluating their heat technology and production efficiency. Carrying on regardless with the same heat legacy issues is neither sensible nor profitable.

A time for review inevitably means taking a fresh look at Infrared (IR) heat technology.'

This is an evergreen message that Frank Wilson, Ceramicx founder and MD never tires of reiterating.

'Despite the advances in fracking and shale gas, US manufacturing industry, for example, is still being incentivised to go green. For many thermoformers this means an adoption of IR-based heating and sophisticated control as a way of increasing accuracy and saving cost,' says Wilson, currently making preparations with distributor Weco International to exhibit at NPE 2015 (please see pages 14, 15.)

'The first building block is great IR thermoforming platen design and build. The second building block is to combine that with pin-point accurate electronic and process control.

'The primary outcome and benefit,' says Wilson, 'is that the customer is offered improved efficiency through decreased energy usage. This in turn enables increased production, reduced scrap and reduced downtime.'

Getting new IR heating systems designed and installed for thermoformers typically requires 3-4 days onsite for integration, including a 24 hour runoff period. These schedules typically apply at any site in the world.

Ceramicx believes that any thermoforming control system should also provide early warning diagnostic features; the ability to alarm the operator in the event of a single heater loss, a shorted wire or bad fuse.



Commissioning of the new oven on the customers site

Ceramicx experience is that most plastics thermoformers experience heating issues at some point in the life of their thermoforming machine. 'The heating issues of the past ten years for thermoformers worldwide are broadly the same, says Wilson, 'and until we see a wholesale adoption of efficient IR based heating – the core messages to all thermoformers will be the same.'

Those messages include the assertion that a simple infrared (IR) heating upgrade to a company's conventional heating system can increase profits for thermoformers by at least one third, according to Ceramicx, and perhaps more consistently at 40% saving.

Replacing an entire thermoforming machine is too big a step for many but an IR oven upgrade can improve the performance of an expensive fixed capital asset and often pays for itself within months.

Conventional heating legacy issues can include burn outs, electrical faults and problems with older style and non-directional heating. Tubular and magnesium filled heating solutions; black rod heating and other kinds of non-infrared sources can all make a contribution to inexact systems of thermoforming production and – above all – to a waste of energy and electricity cost.

In a completely enclosed system or oven, this kind of heating becomes uncontrollable. As the system gradually weakens and loses power thermoforming operators are being continually forced to ramp up the power and the input electricity in order to try and maintain an even temperature. Such operating behaviour leads to further failures and expense.

Ceramicx believes that IR-based heating solutions for thermoformers include the following benefits:

- Major reduction in capital equipment wear and tear
- Ceramic/Quartz Infrared for tubular replacements
- Elimination of 'hot box' tubular problems
- Poor performing infra red to be replaced with superior platens
- Savings in directional heat
- Better resultant product quality
- Improved set up time and tool change time
- More complex parts possible

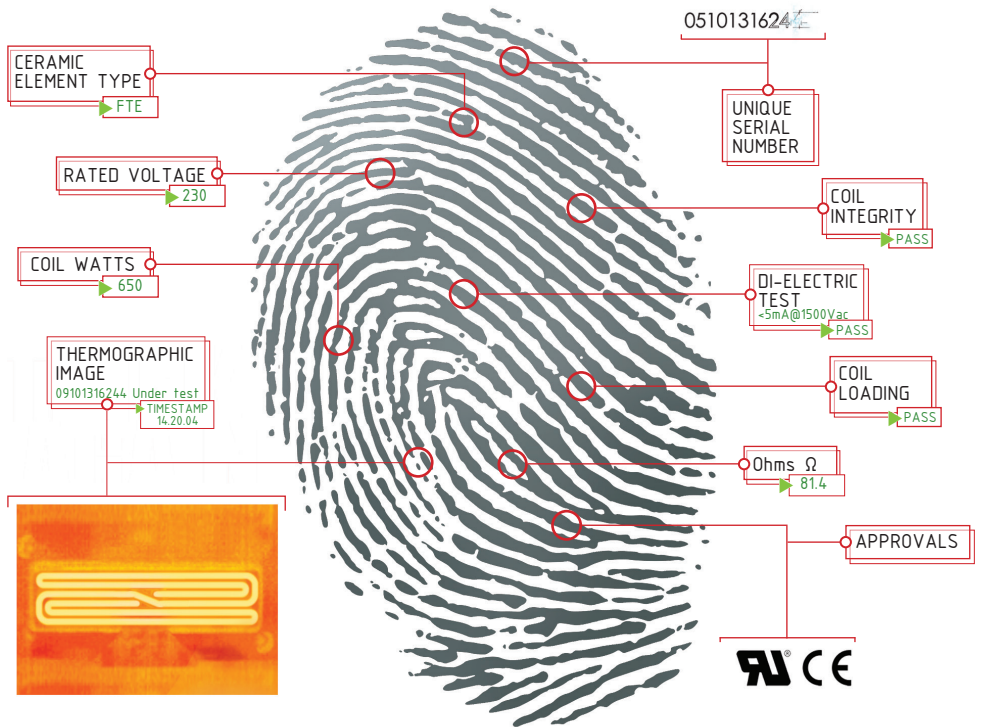

Every Ceramic element goes through a battery of tests listed above. The birth certificate is available for each element once you enter the serial number on the ceramicx website . www.ceramicx.com/birthcert/

- Cooling requirements also reduced
 - Matching of heating controls to polymers being processed
 - Improved environment for operators
- Ceramicx-designed IR-based thermoforming systems essentially convert incoming electrical wattage into infrared output more quickly and efficiently.

Ceramicx-produced IR components are made to the highest quality assured (QA) systems. Each ceramic component, for example, has its own unique 'thumbprint' for example – the exact specifications for which are all available to the purchaser/user. All components feature closely specified nominal wattage tolerances for the ceramic and quartz electrical elements. This control applies throughout the entire range of Ceramicx products. A semi automated validation system with closed-loop process-control guarantees the product quality. It also assigns and records performance characteristics ('thumbprint') for each part as it is produced.

In thermoforming production a number of infrared ceramic heaters are generally mounted on reflectors which are then arrayed upon a platen – or two – which is part of the production line.

The performance of the background reflectors - their material composition - and the performance of the platen in general – these factors are all vital in directing the infrared heating to the plastic.

For example, Ceramicx points out that stainless steel is not an adequate material for use in infrared reflection work. It will absorb a high percentage of the emitted energy and will therefore over time cause burnout of the electrical wiring behind the reflector and will also start to discolour from 120°C. Polished aluminium on the other hand is in most cases the best reflector for ceramic infrared heating but >500°C it also will start to fail. The business of thermoforming thin and clear plastic sheet needs some installation of passive ceramic tiles in the base of the platen in order to reflect back the heat.

Every thermoforming system, in some way, has its custom features depending on products, materials and cycle time. The Ceramicx belief is that sooner or later most of these will migrate over to efficient IR based systems in the coming years. The comparative study, part published here, provides further proof of this coming eventuality. ■



Ceramicx joins Elmec Heaters at Plastindia 2015 in Gujurat

Mumbai December 12th-16th was the place and time and Plastivision 2013, India's leading plastics exhibition, was the event that saw Ceramicx IR heating come further to the fore in India.

This February's exhibition in Gujrat sees a full flowering of the relationship with Ceramicx sending its top technical specialists to the show for the full duration.

Ceramicx chose Elmec principally for its pioneering role in India in the manufacture of products that meet the most challenging applications. Established in 1975, Elmec has since specialized in the production of electrical heating elements. The company also provides a fully-fledged and thorough analytical and testing service for the components that make up entire thermal systems.

industrial use throughout India. Elmec is also one of India's major exporters of heaters.

Through research and development, Elmec has also invested in proprietary technology in the areas of hotrunner heaters, cartridge heaters and thermocouples, all of which helps Elmec to achieve greater flexibility for its customers and greater penetration of the heating market.

Elmec Heaters will continue to grow through 2015. Distributorships have lately been established in Bangalore, Mumbai, Delhi and Gujrat and more distributorships are being encouraged by the company.

Dr Cathal Wilson, Ceramicx Director, notes that 'Elmec Heaters has now established a well-known and prominent position in the market for quality work, durability and good customer service and – with help from Ceramicx - is bound to undergo significant expansion in the coming years.'

The Plastindia 2015 stage is waiting for this next chapter in the Ceramicx/ Elmec expansion. The curtain rises on the exhibition on Thursday 5th February. More in the next edition of HeatWorks magazine. ■



Elmec Heaters and Appliances has been key to Ceramicx development across that continent. The relationship began at the K 2010 exhibition in Dusseldorf. A succession of steady orders followed on and as Elmec has expanded its ambitions; product range and offices so has the spread of interest in Ceramicx IR heating.

Proprietor Sundar Sundarraj made the initial contact with Frank Wilson in 2010. Since then the business relationship has gone from strength to strength.

India now stands on the verge of quantum industrial development and Ceramicx is extremely well placed to help Elmec Heaters and Appliances make the most of it. Many thousands of Indian manufacturers are now keen to take advantage of Ceramicx IR heat work know-how in their manufacturing processes.

Elmec design, manufacture and supply all types of Industrial Electric Heaters

Elmec Heaters design, manufacture and supply all types of Industrial Electric Heaters. Strip Heaters, Tubular Heaters, Cartridge Heater, Hot Runner Heaters & Bushes, Manifold Heaters, Infrared Heaters, Cast-in Heaters, Roller Heaters, Temperature Controllers, Thermocouples and many other products for the plastics industries and for manufacturing generally.

From a family-run business, Elmec Heaters and Controllers has now grown into a market leader in the design, manufacture and supply of Heaters and Heater banks for commercial and



Sundar Sundarraj

At Plastivision in Mumbai Ceramicx products were spread across two different booths. Plastindia 2015 sees Ceramicx attend in person and join Sundar and his team on the Elmec Heaters and Appliances booth, HALL 4AD STAND B10A 5-10th February.

Ceramicx sends IR experts to Plastindia marketplace



Dr. Cáthál Wilson, Dr Gerard McGranaghan.

Ceramicx will field its top business and scientific staff at the Plastindia 2015 exhibition this year.

Doctors Cáthál Wilson and Gerard McGranaghan will represent the company and will partner with Elmec Heater colleagues on the latter's booth for the duration of the exhibition.

Dr Cáthál Wilson is a director of Ceramicx Ireland; holds a degree in Engineering from the University of Limerick and a Doctorate in key SME Manufacturing behaviours from the University of Limerick.

Dr. Gerard McGranaghan has a doctorate in thermal engineering from Trinity College Dublin, is Senior Development Manager with Ceramicx Ireland and is also the Operations manager for the Ceramicx Centre for Infrared Innovation (C²I) which is the research arm of Ceramicx Ireland.

Gerard is also an experienced traveller to India: Some twenty years ago he spent a number of spells there and also in Nepal where he was in charge of a UN Vehicle Workshop, maintaining a fleet of 40 vehicles and 40 motorcycles supporting the Bhutanese Refugee Project where his duties included workshop management, training of mechanics, fleet servicing and ordering of parts.

Both men are looking forward very much to working at the show and to doing business with companies in the Indian thermoforming markets and in plastics processing generally. Cáthál Wilson notes that 'Ceramicx has many good things to offer the Indian thermoforming industries; from machinery builders to thermoforming processors. We are excited by India's dynamic economy, its prospects for growth and – with our partners Elmec – we firmly intend to be a part of such expansion.'

Indian plastics roars ahead.....

Irish based businesses will perhaps be forever wary of tiger metaphors for any economy but there is no doubt whatsoever that the Indian native version is set to roar increasingly on the world manufacturing stage for the rest of this decade.

Plastics based manufacturing is also set to play a leading part in this expansion and Plastindia 2015 will be a key event and bellweather in this regard.

One commentator points out that India's per capita consumption of plastics is the lowest in the world, currently estimated at 9.7kg per annum. Therefore, for the huge domestic market alone, the only way is up – with forecasters reckoning that the consumption figure may well double within the next three to four years.

For Western Economy nations, some of the statistics are mind boggling. India's working population of 467 million people is expect to add a further 100 million to that number by 2020. India's average household income is expected to almost triple by 2020.

Indias working population 467 million people

India counts itself as heading towards the third largest plastics market in the world by the year 2020, the same year that India's per capita GDP is expected to double. And by the year 2020 India's plastics processors will deploy more than 180,000 production machines, increased from today's total of 110,000 tonnes.

The confidence within India's plastics processing community is growing: For the fourth time running Plastindia is home to Proplast, a pavilion which is a home and showcase for India's busy plastics processors. This year's pavilion expands to 5000 sq metres of floorspace. India's participating processors will not only aim to show off their production and technology but also their increasing guarantee of quality and export oriented output.

The Indian Government is playing its part and have encouraged the establishment of plastic parks and centres in various Indian states in order to help the growth of plastic industries.

PLASTINDIA

Gujarat, of course, has emerged victorious in the contest to host Plastindia 2015 this year. One determining factor is the increasing attraction of Gujarat as a hub for India's growing automobile industry. Again, India, differs little to the global pattern in that OEM automobile manufacturers seek to surround themselves with Tier 1,2 and 3 suppliers, often close to the main production centres. Consequently, many global entrepreneurs with plastics automotive expertise are locating their production units in Gujarat itself.

The state of Gujarat also sets great store by the Plastindia 2015 hosting venue at its capital city Gandhinagar. Designed by French architect Le Corbusier, the location is also one of India's important financial hubs.

- 120,000 m² of Exhibition Space
- 150,000 Business Visitors
- 2,000 Exhibitors from 40 Countries
- Spread over 45 Acre site

The Plastindia Foundation – which runs the exhibition – and much else besides – expects a record breaking event. 2000 exhibitors will spread themselves out over 120,000 square meters of space in expectation of at least 150,000 business visitors. Plastindia was founded in 1987 and is the apex organisation for India's plastics organisations. It's key focus is to facilitate export led growth.

Ceramicx, for one, in partnership with Elmec Heating, is more than looking forward to forging technology partnerships and sales with all interested parties in India, especially through Infrared Heat work with thermoforming machinery builders and processors. We are looking forward to a great show! ■

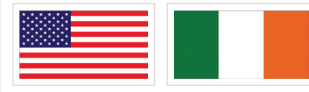

Weco and Ceramicx go Infrared USA!



A stunningly successful trading period for Weco International culminated in the company's exhibition at NPE 2012 Orlando. History this year is looking to repeat itself as Weco is back in Orlando with a booth that is twice as big as previous and with boosted participation from Ceramicx personnel.

Frank Wilson, founder and Ceramicx owner will be in the expanded and experienced Ceramicx delegation this year as both companies seek to push home the clear advantage that their IR heat technology offers to the American thermoforming industries.

And, if the promotional and preview work is done right, the US plastics industry will know far in advance of March 23, 2015, that the Weco/Ceramicx heat solution for fast cycling inline thermoformers offers proven operational savings of 40% in energy cost. These substantial savings have been proven and documented in independent study work that is shortly to be published online by Ceramicx in the form of a White Paper.

The Ceramicx/Weco relationship is now more than 14 years old and Weco has been serving the North American marketplace since 1972. NPE 2015 represents the fourth such NPE exhibition that features both companies exhibiting together. The exhibition will serve to further get that cost-saving message out to the visiting processors and the show will once more put Weco's capabilities into the spotlight.

Weco's extensive product inventory will be on show at NPE 2015 of course. The full array of Ceramicx componentry and engineering services will be to the fore. Showing will be various types of ceramic elements, including ceramic trough elements, also stock ceramic

NPE2015 THE INTERNATIONAL PLASTICS SHOWCASE

23-27 March 2015

Orlando, Florida, USA

South Hall - Level 1

Booth S15168/9



hollow elements, quartz elements, ceramic infrared halogen/tungsten tubes.

Weco testifies that Ceramicx heaters are 'the most efficient infrared emitters on the market because they operate best between the temperature range of 300 to 700 °C (575- 1292 °F), producing infrared wave lengths in the 2- 10 micron range. It is found that many materials and plastics absorb infrared best in this range.'

At NPE Weco will also exhibit HETRONIK multi-channel heat controllers; SCE enclosures; programming port interface modules; transformers and lighting disconnects; specialty wire; and residential/commercial comfort heating solutions

Weco CEO Brett Wehner says that 'Weco will aim to use NPE 2015 to illustrate and demonstrate our slogan of "Putting the Pieces Together", especially in the service of lower production cost for our customers.

Together with Ceramicx, we integrate our product offerings in order to provide new and retrofit oven

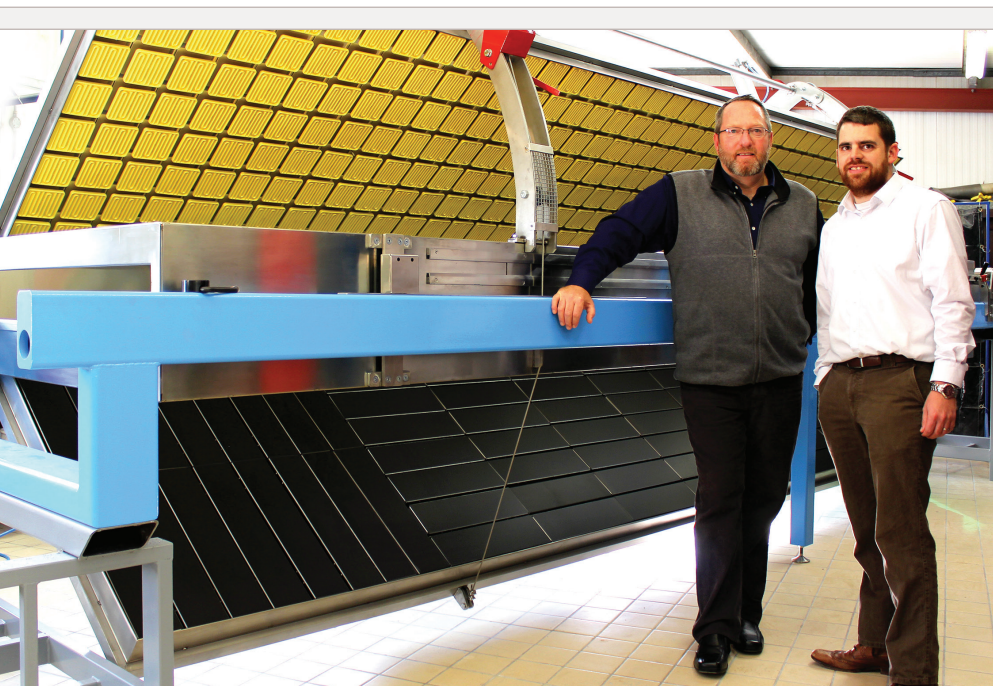

Mr. Brett Wehner, President, Weco International and Dr. Cathal Wilson, Director, Ceramicx, examine a 160kW replacement oven for a thermoformer before shipment from Ceramicx manufacturing facility in Ireland.

assemblies and controls for a variety of infrared heating applications, including forming, curing, and drying. NPE will also give us the opportunity to introduce our new line of Energy Efficient Oven (E2O) modules, giving every customer the ability to "Go Green", stay on budget, and quickly build their own highly efficient long or short wave infrared oven. '

Brett adds that 'in all that we do we aim to create "Intelligent Infrared" with high efficiency elements and



The Herschel available for contract testing or for sale

unlimited zoning control to minimize energy usage, maximize production and reduce scrap.

Our joint business with Ceramicx initially focused on parts and components. Today it has now evolved into world class oven and control solutions for the thermoforming, composites, glass, food, paint, adhesive, and drying industries.

The Ceramicx brand is now thoroughly recognized and respected throughout North America and the world for that matter. We are more than ready for NPE 2015, and are looking forward to growing our businesses together.' ■

WECO'S GOT TALENT...SERVICE AND SAVING

Weco International has lately been investing in a number of resources to enable its US customers to choose the solution that is both technically appropriate and also offers the most operational savings.

These Weco services allow customers to 'dry run' their production ideas and/or production solutions, while getting to know the clear benefits of the IR based equipment. IR heat work is most often a case of temperature, radiation and emissivity meeting a variety of target materials – different kinds of materials for example.

The Weco test facilities ensure that the customer is assured of predictable and repeatable results once the equipment is purchased and installed at the company plant.

The first suite of test-before-you-buy opportunities involves Infrared emitters.

Long/Medium/Short Wave Infrared Testing with IR Emitters

Material testing with all waveband emitters to determine best waveband to achieve fastest heat up time/forming temperature

Infrared testing of customer supplied material versus heater type

Determine the best emitter based on fastest cycle time on single product (material specific) dedicated machines

Determine the best emitter for fastest cycle times across a variety of products on multiple product code machines

Weco customers may also 'dry run' their ideals and materials through a variety of test rig IR ovens.

Long/Medium/Short Wave Infrared Test Oven

Test IR ovens for material versus heater type evaluations

Supplied with 3 interchangeable heating platens containing

Long wave ceramic elements	6 kW (16 x 375W)
Medium wave quartz elements	6 kW (16 x 375W)
Short wave halogen tubes	8 kW (4 x 2000W)

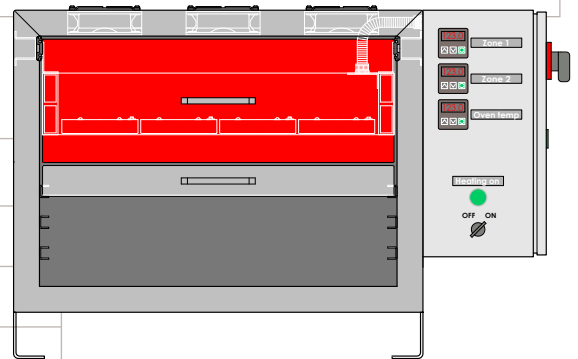

Total electrical load	6 kW to 8 kW
Power supply	Single phase 240 V 40 A minimum recommended
Maximum power density	3.9 W/cm ² (25 W/in ²)
Maximum sheet size	450 x 350mm (17.7" x 13.8")
Control Type	2 zone open loop percentage control
Power switching	Phase angle fired SCR's (thyristors)
Total fan power	96 W (6 x 16 W)
Platen reflectors	Polished aluminised steel (500°C/932°F max)

Overall size	864 x 559 mm 34" x 22"
Footprint	664 x 524 mm 26 1/4 x 20 3/4"
Height	565 mm 22 1/4"
Approvals	CE
Includes power cable, device over current protection and thermally insulated side walls	

Weco also offers both renting and purchasing options for both emitters and ovens. All testing fees can subsequently be credited towards a new oven purchase.

Weco's varied portfolio



Mr Brett Wehner, President, Weco International.

Weco's range of Infrared heat activity for US clients is very extensive. The company's project work in the USA is currently by some distance the most challenging, innovative and varied within the Ceramicx portfolio.

Fast cycling and inline thermoforming heat work upgrades are a significant part of the Weco IR heat work portfolio. Weco counts many satisfied clients within the US packaging industries. Within US packaging the large market segment of food service items predominates; food containers; boxes; cups vending items and fast moving consumer goods (FMCG) generally.

Not only does Weco retrofit existing thermoforming systems for the production of these volume goods – thereby saving energy costs by an average of 40% - the company also undertakes other significant heat work for such FMCG producers; supplying IR components on a JIT basis; designing and building systems to dry out polymer recycle and regrind; revamping the electronics in production control systems and providing many other services in this most competitive area of manufacturing. Increased cycle time and output are critical here – but so are production systems. Burnouts, conventional heating failures and line stops have taught many producers to invest in the precision and control offered by an IR-based heating system.

In common with the rest of the world Weco engineers find many misunderstandings and misapprehensions about the nature of IR heat within the US manufacturing community, most often based on considerations of temperature alone, and exclusive of issues of radiation and emissivity. Effective Infrared communications work is therefore a key part of the Weco portfolio.

Communicating the benefits of IR heating applies also to Weco's work in cut sheet fed thermoforming operations – for larger items, for example, in the automotive, construction sports and leisure markets. These thermoforming systems often struggle with an inefficient and outmoded heating legacy as part of their production process. Weco's role, most typically, is to help take this kind of production into the 21st century, using a mixture of renewed and effective process control and targeted IR heating with Ceramicx products.

Other US manufacturers – in automotive and construction sectors – also welcome the features and properties of the IR heat source when it comes to processes of gluing, adhesion, drying and curing. The quality and 'throughput' of the IR heat source and the added annealing benefit in many situations

makes it favoured in much automotive paneling and jointing work and in bonding diverse materials together.

Examples of the latter are found in the oil and gas industries; a sector where Ceramicx also has considerable Scandinavian experience. Pipeline suppliers in Texas, for example, have benefitted from Weco/Ceramicx solutions in plastics to metal bonding.

Ceramicx and Weco have also delivered large turnkey oven systems to blue chip companies who have sought and succeeded in a radical new look at their methods for heating and transforming materials; particularly in plastics, in glass and in other materials where the exact control of high temperatures is required.

Weco is as comfortable in the 'Mom and Pop' shop as in the Fortune 500 boardroom. 'Service, says CEO Brett Wehner, 'has always been the most important feature of our company since 1972' In practical terms that means empathy with the client and the client needs. The new emitter and oven testing services, for example, are a manifestation of this

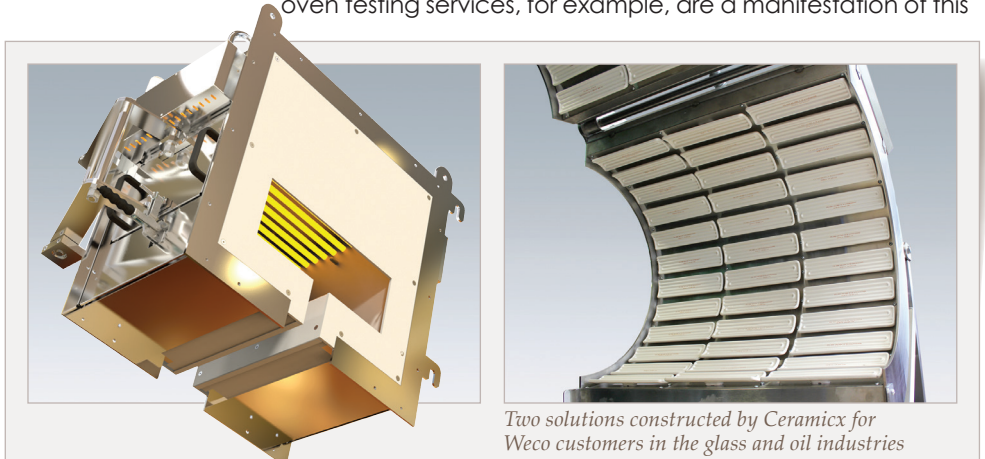

Two solutions constructed by Ceramicx for Weco customers in the glass and oil industries

process, ensuring that the Weco customer gets exactly what they require and are also fully trained in order to realize optimum value from their equipment.

Weco service can often mean crossing the country through difficult weather; working through weekends and the holidays, doing everything possible in order to reach the best possible heat work solution for the client.

The proof of 'best possible' often includes: fault free operations; upgrades to further machines, very short ROI periods and substantial energy savings. Weco/Ceramicx conservatively quote 20-30% but the majority of clients most often indicate 40%+ savings. And this latter point can often win the Weco customer further savings in the form of State and/or Federal funding for energy saving activities. ■



Ceramicx builds its stake in Turkey's powerhouse economy.

2015 sees Ceramicx making further investments in its Turkish and Middle Eastern Infrared heating markets. Ceramicx in Turkey, will this year be established in the Istanbul industrial area under the management of Hasan Duman, formerly with distributor Ser Rezistans.

Hasan notes that 'Turkey's industrial development continues strongly and the political situation is relatively stable. These factors makes Istanbul's location as a trade centre, ever more important in the coming years.' The company's new location there is set to further boost sales of Ceramicx components and heaters.

The Ceramicx appeal

Ceramicx has been active in the Turkish market for over four years now; building customers and market share through the quality and efficiency of its products. Hasan notes that approach has succeeded 'and now the Turkish market wants more – closer cooperation, closer relationships, stock holding, components and further complete infrared systems. Our new company will more than match these demands, and will also develop further leading edge IR heat projects for everyone's benefit.'

The Ceramicx professionalism and expertise in the general science and engineering of Infrared Heating is also much appreciated in the Turkish market where the company is seen to foster the research and development of new IR products. The Ceramicx product 'birth certificate' for each and every ceramic component has also won many friends in Turkish Manufacturing.

Turkey provides sales for Ceramicx supplied Infrared ceramic long wave emitters, Quartz medium wave emitters and medium to shortwave quartz tungsten and halogen tubes. The company's IR education process – via the website, HeatWorks magazine and other outlets – is also popular. Hasan notes that 'in common with many regions, Turkey sees a lot of IR heating misapplication in industry. This is actually an opportunity for Ceramicx and gives a window within which we can provide many solutions.'

Turkey's growing economy

Turkey's economy continues to outpace many others in Europe. In addition to packaging, the leading sectors are automotive and construction. Automotive continues to lead the durable plastic manufacturing industry which is important

for our business. The construction industry also continues to provide much growth.

Faced with the challenges of such growth the Turkish Machine Industry has had ample opportunity to hone its trade and develop its credentials. Ceramicx expects to find ready customers in this part of industry, having attracted a high level of interest from machinery builders at Turkey's plastics and packaging shows – principally from builders of thermoforming and blow moulding machines.

Plast Eurasia, Istanbul, for example, is the biggest plastic fair in the region. Ceramicx IR heaters of all types have been shown there as well as Ceramicx products such as connectors, holders, and reflectors as well as system solutions and whole platens.

Hasan says that 'Turkey has a big agenda to serve in terms of its growth. The country aims to make investments based upon research and development. Infrared heating technologies definitely serve that agenda and IR heat can lead the way for a great number of manufacturing process and industries.'

Hasan also notes that 'Turkey's green industries are also growing; such as wind turbine manufacture. there are a whole spread of composite industries and technologies. Again, here is a tailor-made role for Ceramicx know-how to help develop Turkish industry.'

The composites sector leads naturally to parts of the military sector and to Turkish ambitions in aircraft manufacturing. Within the past year the "Hürkuş" (freebird) project has been completed and presented. Turkey's next aim is to develop and complete its fighter jet project before 2023. Ship and tanks projects are also developing at pace.

Hasan also asserts that Turkey's plastic manufacturing capacity now stands at 3rd place in Europe and that it continues to grow. On that score alone the country presents an attractive outlet for Ceramicx engineering solutions

The new Istanbul office will open for business by the end of February – a fact that Hasan says will bring a '100% focused team to the Turkish market. Stock levels and diversity of product will deliver competitiveness and availability.

And we believe that project and product developments will follow on from this investment in a very short time. We look forward very much to doing business with you from our new offices in Istanbul!' ■



Mr. Hasan Duman, Manager of Ceramicx in Turkey

Hasan's Contact Details

Ceramicx Ltd.

İkitelli OSB Giyim Sanatkarları Is ve Tic. Mrk.
3.Ada A Blok No:102 Basaksehir, Istanbul, Turkey.

Tel: +90 212 549 4839 Mobile:+90 544 237 2649

Email: hasan.duman@ceramicx.com

www.ceramicx.com

Get the IR heat training!

Dr Gerard McGranaghan of Ceramicx reminds customers and infrared users about the Ceramicx Online Infrared Training Course, .

Ceramicx now host a complete online training course on Industrial Infrared heating and the course has enjoyed good take up and interest from partners and clients alike.

We now take this opportunity to remind readers of the online course which is completely free of charge for industry professionals.

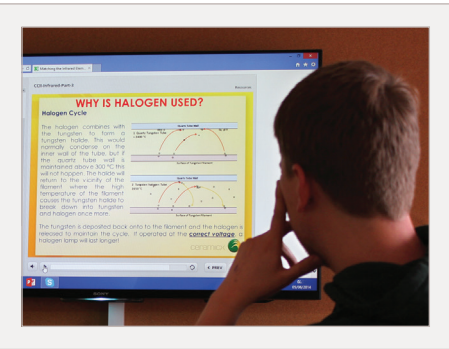

A better understanding of Infrared, is not beyond the reach of anyone involved in the infrared arena. All disciplines—whether in sales, installation, or design can benefit from an enhancement of IR heating knowledge. At Ceramicx we have designed our modules to put you and your companies infrared knowledge on a sound footing; from the very basics to theoretical aspects, to practical industrial situations, with a few tips and tricks along the way.

The aims of the new course are to convey out the basics of Infrared from an industry perspective. The course is set out in four modules, and can be taken online, or even as a taught classroom course.

The modules are

1 Fundamentals of Heat transfer and Infrared

The first module covers the basics of infrared from a theoretical and practical standpoint. This is combined with a refresher on heat transfer putting students on a sound level for the subsequent modules.

2 Infrared Energy in Process Heat

The second module builds on the industrial aspect introducing the key processes that utilise infrared heating as well as some more theoretical aspects of IR. Conventional processes such as thermoforming are explained, and some

novel methods are described so as to familiarise the student with the large breadth of Infrared applications.

3 Matching the Infrared Element to the Application

The third module shows how to match the element to the application, a pre-requisite for the success of any infrared installation. This module links the IR knowledge from module 1 with process knowledge from module 2. Absorption characteristics of common materials are introduced and some practical examples and tips are also given.

4 Control of Infrared

The final module is on the control of Infrared and includes temperature sensors and basics of control systems. The thermocouple is introduced and its advantages and disadvantages discussed. Alternative sensors are also covered as are non-contact thermal sensors. Finally, an introduction to control systems covers the basics of switching, control, PID and construction of larger systems.

Each module is expected to take around 60-90 minutes, and each module also finishes with a short online test where the results will be emailed to the student. The student may re-take the test a number of times.

Although taking the course will not guarantee to make one an expert in IR, nonetheless Ceramicx hope that the user will now be sufficiently knowledgeable about IR so as to have confidence in dealing with colleagues, customers and clients, and that this will benefit all in the business of Infrared.

On successful completion of the course, the student will be sent a certificate of competence from Ceramicx.

Sign up via the training link on the ceramicx homepage or via the link at <http://www.ceramicx.com/applications-training/>

Ceramicx Infrared Training

Module 1 Fundamentals of Heat transfer and Infrared
Module 2 Infrared Energy in Process Heat
Module 3 Matching the Infrared Element to the Application
Module 4 Control of Infrared

The course is now available online Free to Ceramicx customers, distributors and related practitioners in infrared or process heat (subject to approval) at <http://www.ceramicx.com/applications-training/> or alternatively contact us for further details.

Normal subscription is £150 per module and exam (i.e., £150 each for part 1, Part 2 etc.) or £42 monthly recurring for all modules (£500 annually, minimum subscription 12 months). Further modules will be added on an ongoing basis.

If you'd like Ceramicx to provide classroom training, this can be arranged either at Ceramicx in scenic West Cork, or in a location of your choice (cost available on application).

CLAMSHELL OVEN CSH 12.1kW

Oven type	Combined radiant/convective
Total Power	12.1kW
Power supply	3 x 400V + N + PE
Maximum current/phase	18A
Maximum operating temp	650°C (1292°F)
Element type	Short wave quartz halogen.
Total heating power	12kW (6 x 2kW)
Total fan power	96W (6 x 16W)
Control zones	3
Control type	3 zone open loop (with optional single zone closed loop)
Controller	Cannon Automata F3
Control interface	Touchscreen HMI
Power control	Phase angle
Temperature measurement	Single type K thermocouple (measuring air temperature)
Opening mechanism	Pneumatically operated
Air supply pressure	6 Bar
Footprint (oven closed)	1153 x 991mm (45.4" x 39")
Footprint (oven open)	1400 x 991mm (55.1" x 39")
Overall height (from floor)	1350mm (53.1")
Oven length (entry to exit)	991mm (39")
Effective heated length	740mm (29.1")
Entry/exit diameter	150mm (5.9")
Maximum product diameter	100mm (3.9")
Approvals	CE

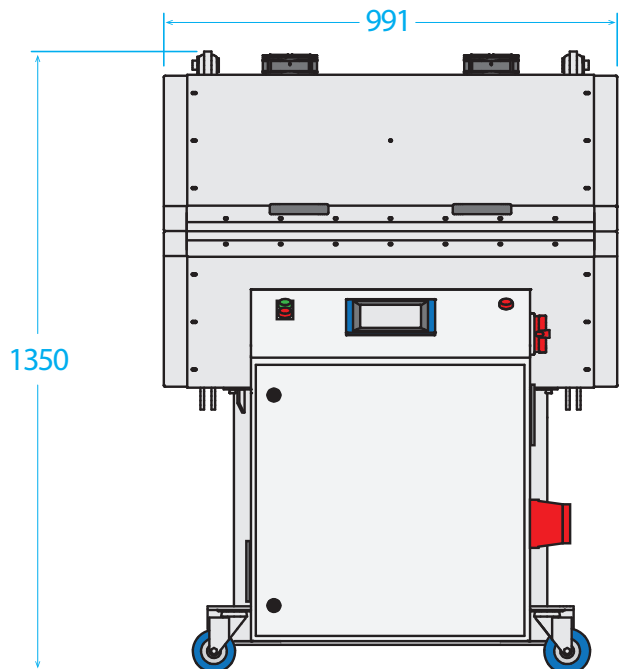
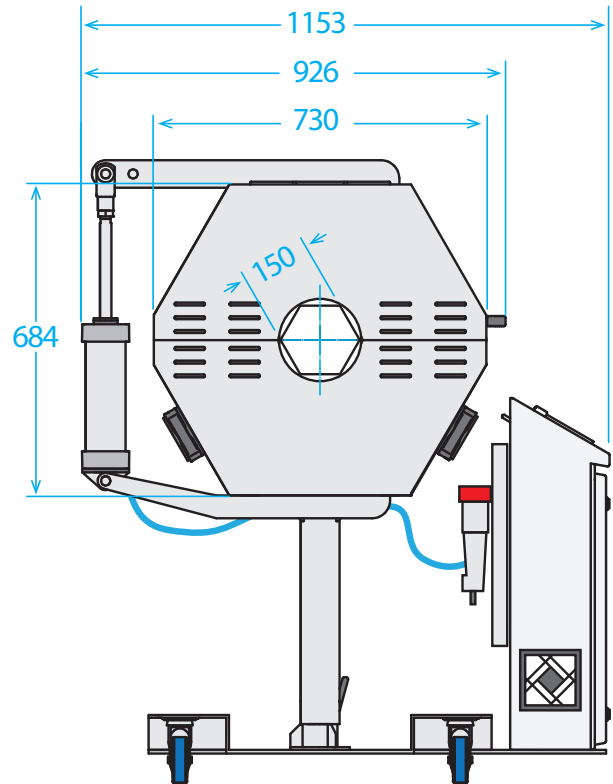

All dimensions mm
Tolerances apply



CERAMIC ELEMENTS

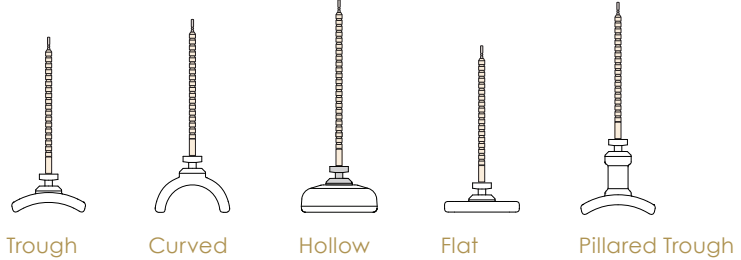

Trough

Curved

Hollow

Flat

Pillared Trough

CERAMIC TROUGH ELEMENTS

www.ceramicx.com/trough-elements/

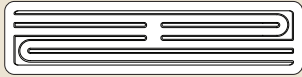

FTE / FTE-LN

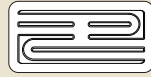

HTE



QTE / QCE

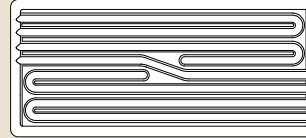

LFTE

FTEL - LN

FTE Full Trough Element	245 x 60 mm	150W 250W 300W 400W 500W 650W 750W 800W 1000W
HTE Half Trough Element	122 x 60 mm	125W 150W 200W 250W 325W 400W 500W
QTE Quarter Trough Element	60 x 60 mm	125W 250W
QCE Quarter Curved Element	60 x 55 mm	150W 250W
LFTE Large Full Trough Element	245 x 110 mm	1000W 1500W
FTE-LN Full Trough Element -Long Neck	245 x 60 mm	250W 400W 500W 650W
FTEL-LN Full Trough Element Long - Long Neck	285 x 60 mm	1000W

CERAMIC HOLLOW ELEMENTS

www.ceramicx.com/hollow-elements/



FFEH



HFEH



QFEH

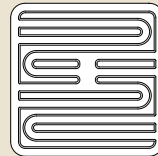

SFEH

FFEH Full Flat Element Hollow	245 x 60 mm	250W 400W 500W 600W 800W
HFEH Half Flat Element Hollow	122 x 60 mm	125W 200W 250W 300W 400W
QFEH Quarter Flat Element Hollow	60 x 60 mm	125W 200W
SFEH Square Flat Element Hollow	122 x 122 mm	250W 400W 500W 600W 800W

CERAMIC FLAT ELEMENTS

www.ceramicx.com/flat-elements/



FFE



HFE



QFE

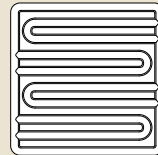

SFSE



LFFE

FFE Full Flat Element	245 x 60 mm	150W 250W 300W 400W 500W 650W 750W 1000W
HFE Half Flat Element	122 x 60 mm	125W 150W 200W 250W 325W 500W
QFE Quarter Flat Element	60 x 60 mm	125W 250W
SFSE Square Flat Solid Element	122 x 122 mm	150W 250W 300W 400W 500W 650W 750W
LFFE Large Full Flat Element	245 x 95 mm	150W 350W 750W 1400W

THERMOCOUPLES

www.ceramicx.com/thermocouples/

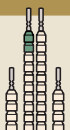

Thermocouple Type K
+ Nickel Chromium
- Nickel Aluminium

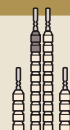

Thermocouple Type J
+ Iron
- Copper Nickel



ESEB



ESES

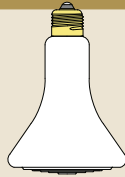

ESER

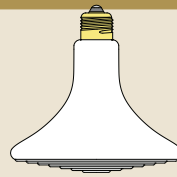

ESEXL

- ESEB** Edison Screw Element Ball
- ESES** Edison Screw Element Small
- ESER** Edison Screw Element Regular
- ESEXL** Edison Screw Element Extra Large

Ø65 x 140 mm	60W 100W
Ø80 x 110 mm	100W
Ø95 x 140 mm	150W 250W
Ø140 x 137 mm	400W

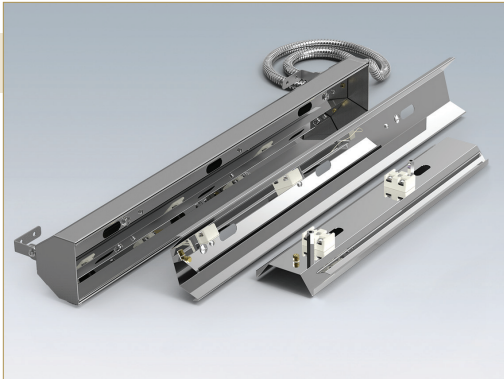

REFLECTORS / PROJECTORS

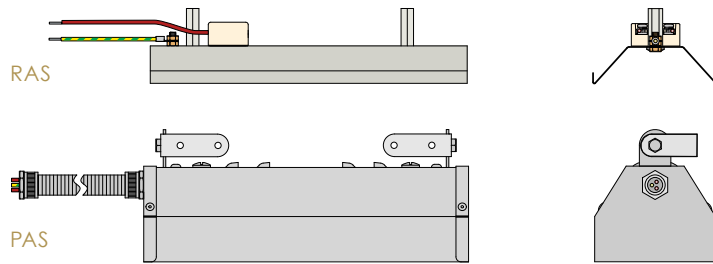

REFLECTORS

- RAS 5** Reflector Aluminised Steel 5 1,254 x 100 mm
- RAS 4** Reflector Aluminised Steel 4 1,004 x 100 mm
- RAS 3** Reflector Aluminised Steel 3 754 x 100 mm
- RAS 2** Reflector Aluminised Steel 2 505 x 100 mm
- RAS 1** Reflector Aluminised Steel 1 254 x 100 mm
- RAS 0.5** Reflector Aluminised Steel 0.5 160 x 100 mm

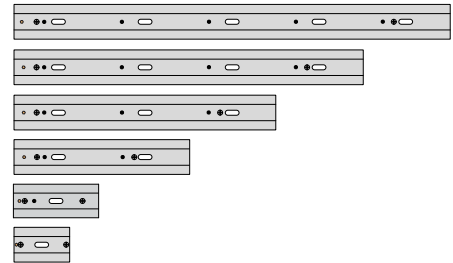

PROJECTORS

- PAS 5** Projector Aluminised Steel 5 1,258 x 94 mm
- PAS 4** Projector Aluminised Steel 4 1,008 x 94 mm
- PAS 3** Projector Aluminised Steel 3 758 x 94 mm
- PAS 2** Projector Aluminised Steel 2 508 x 94 mm
- PAS 1** Projector Aluminised Steel 1 258 x 94 mm

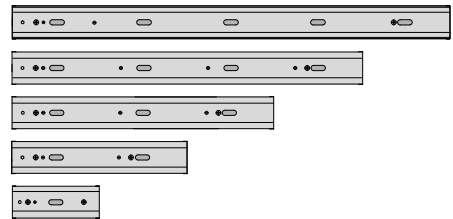

INSTALLATION OF PILLARED ELEMENTS

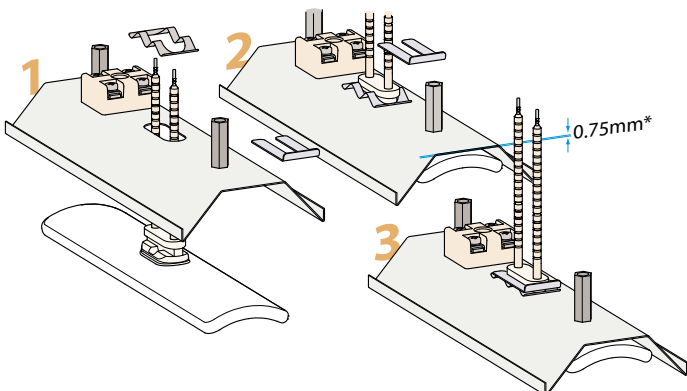

Recommended reflector thickness 0.75 - 0.9mm
(minimum/maximum thickness 0.5 - 1.5 mm)

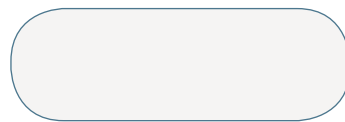

Slot hole size 42 x 15 mm

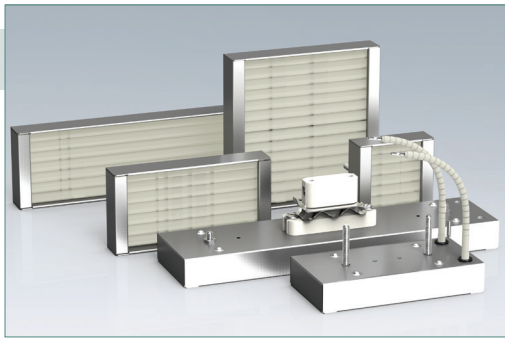

QUARTZ ELEMENTS

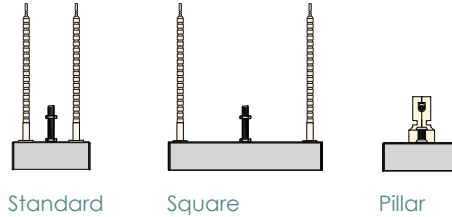

Standard

Square

Pillar

STANDARD QUARTZ ELEMENTS

www.ceramicx.com/standard-quartz-element/

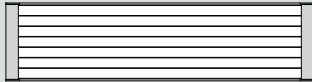

FQE

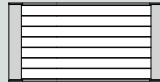

HQE



QQE

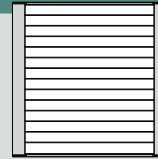

SQE

FQE Full Quartz Elements	247 x 62.5 mm	150W 250W 400W 500W 650W 750W 1,000W
HQE Half Quartz Element	124 x 62.5 mm	150W 250W 400W 500W
QQE Quarter Quartz Elements	62.5 x 62.5 mm	150W 250W
SQE Square Quartz Element	124 x 124 mm	150W 650W 1,000W

PILLARED QUARTZ ELEMENTS

www.ceramicx.com/pillared-quartz-elements/

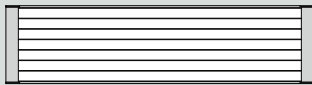

PFQE

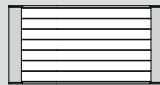

PHQE

PFQE Pillared Full Quartz Elements	247 x 62.5 mm	150W 250W 400W 500W 650W 750W 1,000W
PHQE Pillared Half Quartz Element	124 x 62.5 mm	150W 250W 400W 500W

CURVED QUARTZ HALF ELEMENTS

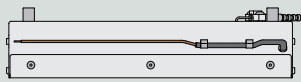

CQHE

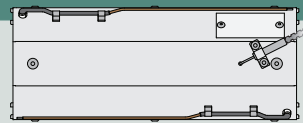
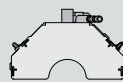

CQHE 500 Curved Quartz Half Element 500mm	500 x 100 x 62 mm (inc stand off's)	Max Wattage 1,250W
CQHE 250 Curved Quartz Half Element 250mm	250 x 100 x 62 mm (inc stand off's)	Max Wattage 625W
CQHE 100 Curved Quartz Half Element 100mm	100 x 100 x 62 mm (inc stand off's)	Max Wattage 250W

SQUARE QUARTZ TUBE ELEMENTS

www.ceramicx.com/quartz-square-tube-elements/

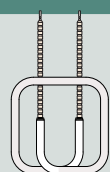

STQH 100

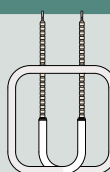

STQH 112

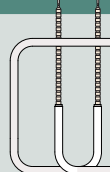

STQH 140

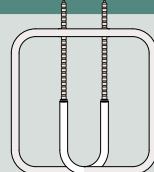

STQH 150

STQH100 Square Tube Quartz Heater	100 x 100 mm	150W - 400W
STQH112 Square Tube Quartz Heater	112 x 112 mm	150W - 400W
STQH140 Square Tube Quartz Heater	140 x 140 mm	150W - 650W
STQH150 Square Tube Quartz Heater	150 x 150 mm	150W - 650W

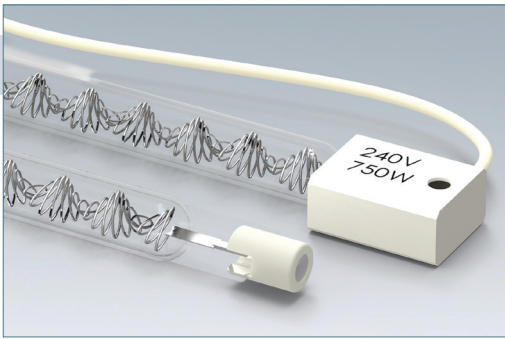

QUARTZ TUNGSTEN / HALOGEN

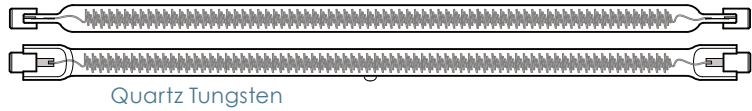

Quartz Tungsten



Quartz Halogen

QUARTZ TUNGSTEN TUBES

www.ceramicx.com/fast-medium-wave-emitters/



QTS



QTM



QTL

QTS Quartz Tungsten Short	Ø10 x 244 mm	750W
QTM Quartz Tungsten Medium	Ø10 x 277 mm	1000W
QTL Quartz Tungsten Long	Ø10 x 473 mm	1500W 1750W 2000W

QUARTZ HALOGEN TUBES

www.ceramicx.com/short-wave-emitters/



QHS



QHM



QHL

QHS Quartz Halogen Short	Ø10 x 244 mm	750W
QHM Quartz Halogen Medium	Ø10 x 277 mm	1000W
QHL Quartz Halogen Long	Ø10 x 473 mm	1500W 1750W 2000W

QUARTZ TUNGSTEN/HALOGEN REFLECTORS

www.ceramicx.com/reflectors/

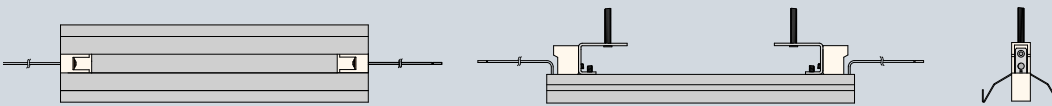

QTSR Quartz Tungsten/Halogen Short Reflector	250 x 62 mm	(Suitable for QTS/QHS, Tubes supplied separately)
QTMR Quartz Tungsten/Halogen Medium Reflector	300 x 62 mm	(Suitable for QTM/QHM, Tubes supplied separately)
QTLR Quartz Tungsten/Halogen Long Reflector	497 x 62 mm	(Suitable for QTL/QHL, Tubes supplied separately)

SPECIAL TUBE ORDERS

www.ceramicx.com/special-tube-orders/

Ceramicx can supply other types of Halogen/ Tungsten elements, of varying design, dimensions, length, coatings, terminations and electrical rating.

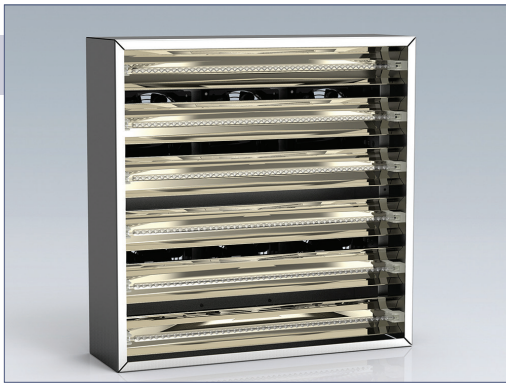

FAST IR

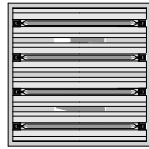

FastIR 305

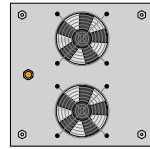

FastIR 500

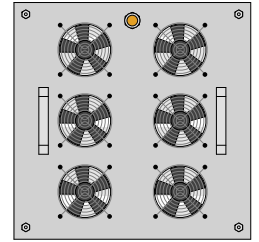
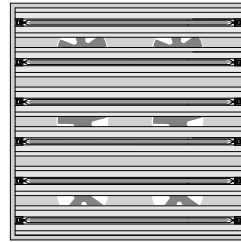

FAST IR

www.ceramicx.com/fastir-systems/

FastIR 305 Suitable for 1000W Quartz Tungsten/Halogen Heaters QTM/QTH (tubes sold separately)
 305 x 305 x 150 mm **4 Tube 4kW** **5 Tube 5kW**

FastIR 500 Suitable for 2000W Quartz Tungsten/Halogen Heaters QTL/QTL (tubes sold separately)
 500 x 500 x 150 mm **6 Tube 12kW** **7 Tube 14kW**

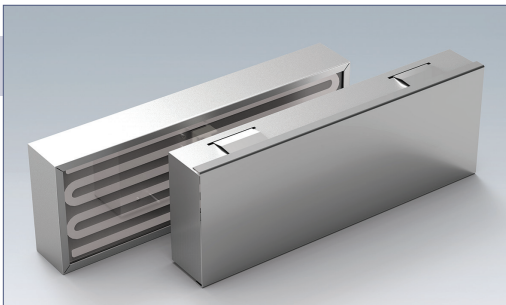

CUSTOM PANEL HEATERS

Custom Panel Heaters.
 Available with anodised aluminium or ceramic glass face.
 Range of Wattages and Voltages.
 Multi-zone options with removable miniature thermocouple plug.

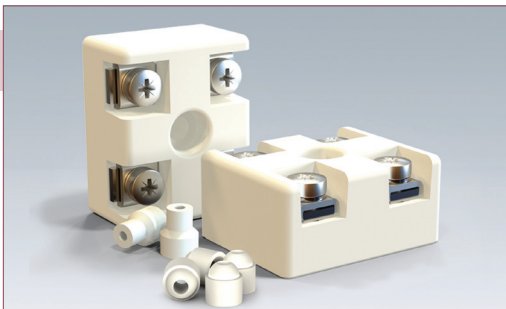

STEATITE

Steatite ceramic dust has proven itself to be the material-of-choice for the manufacture of electrical insulators. It has good mechanical strength with good dielectric properties and a high temperature resistivity of up to 1000°C.
 Steatite is most commonly used in applications where a high temperature electrical insulator is required. It operates very well in cold switching applications and is also an excellent high voltage insulator.

SPECIALISED STEATITE COMPONENTS www.ceramicx.com/specialised-dust-press-components/

Ceramicx now offers the manufacture of specialist Steatite ceramic dust press components to companies that need quality insulators as part of their product manufacturing. For over twenty years Ceramicx has been shipping components and products to manufacturers in over 65 countries worldwide. Service, confidentiality and world class quality is offered, together with a unique know-how in developing and designing product solutions in Steatite Ceramic where needed.



Ceramicx manufactures dust press components on Dorst 20 and 15 tonne presses (shown above) and a Dorst 6 tonne press

A selection of parts that can be purchased

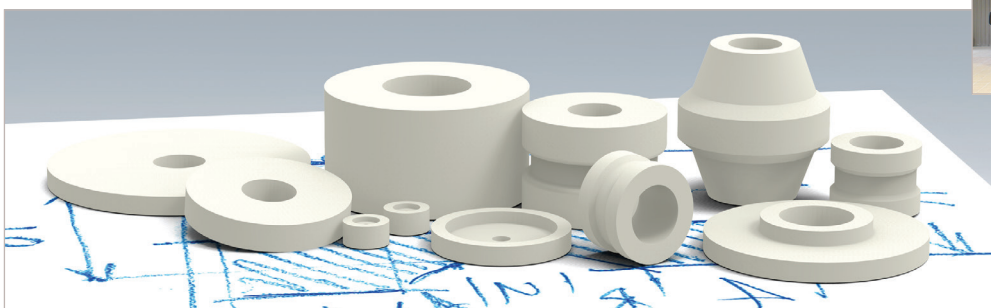

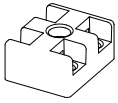
2P Ceramic Terminal Block

10 Pack
no Fittings
40 x 32 x 20 mm

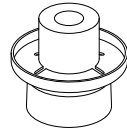
Ceramic Grommet and Starlock

Fastener Set 100 sets
per pack - used as an
Insulator in sheet metal
with 6mm hole
21 x 18 x 15 mm

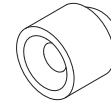
Ceramic Beads

per kg
Loose or Strung
Ø5 x 6 mm
4.5 mm to shoulder

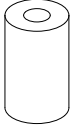
Ceramic Tubes

Ø5 x 11 mm

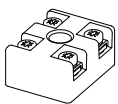
ACCESSORIES**HIGH TEMPERATURE CONNECTORS**www.ceramicx.com/high-temperature-connectors/**2P Ceramic Terminal Block**

10 Pack
Stainless Steel
Fittings
40 x 32 x 20 mm

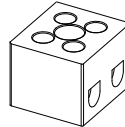
2P Mini Ceramic Terminal Block

10 Pack
Nickel Galvanised Brass
Inserts, Zinc-plated Steel
Screws
21 x 18 x 15 mm

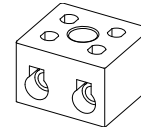
TB2 Ceramic Terminal Block

(closed) 10 Pack
Plated Brass Inserts,
Nickel Galvanised
Screws
34 x 30 x 22 mm

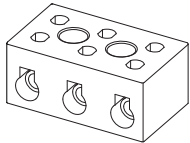
TB3 Ceramic Terminal Block

(closed) 10 Pack
Plated Brass Inserts,
Nickel Galvanised
Screws
51 x 30 x 22mm.

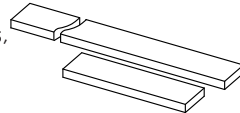
Stainless Steel Buzz Bar

used with the ceramic
terminal block to
produce a flexible power
distribution system
8 x 2 x 1000 mm

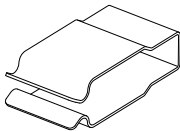
MOUNTING COMPONENTSwww.ceramicx.com/mounting-components/**Flat Ceramic Base Holder**

For Halogen/Tungsten
heaters fitted with flat
ceramic base

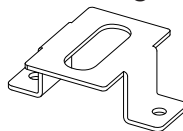
Mounting Bracket

For ceramic elements
72 x 57 x 28 mm.
slot 42 x 15 mm

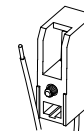
R7s Ceramic Holder

For Standard Quartz
Tungsten/Halogen Tubes

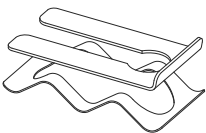
Steel Wave and Spring set

Used in the mounting
and installation of all
Ceramic elements
and the Pillared
Quartz elements

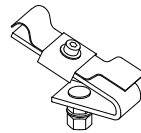
STQH Holder

For all types of square
tube Quartz Heaters
(STQH)

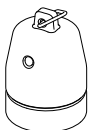
E27 ACCESSORIESwww.ceramicx.com/bulb-reflector-and-e27-holder/**E27 Edison Bulb Holder**

High temperature
porcelain holder used
with ceramic IR bulbs
Ø53 x 74 mm

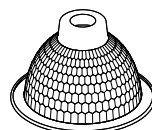
Ceramic Bulb Reflector

Highly polished
reflector for use
with ceramic IR bulbs
Ø220 x 110 mm

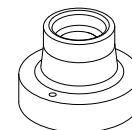
E27 Bulb Holder with Base

High temperature
porcelain holder used
with ceramic IR bulbs
Ø78 x 60 mm

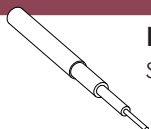
HIGH TEMPERATURE NPC CABLEwww.ceramicx.com/high-temperature-npc-cable/**High Temperature NPC Cable**

Single Conductor Cable, Flexible Nickel Plated Copper Core, Glass Fibre Insulation, Silicone Coated Fibreglass Braid
0.75 mm, 1.5mm, 2.5mm, 4.0mm



Ceramicx Christmas Party

Ceramicx celebrated our Christmas party with a night out at Curraheen Park Greyhound Stadium in Cork City. Food, gambling, dancing, money won and lost but a great night was had by all.

Ceramicx would like to thank **Tobias Brechtelsbauer**, IT Intern from FAU - University of Erlangen-Nuremberg, Bavaria, Germany. Toby will complete his internship at Ceramicx at the end of February.

Toby integrated really well into Ceramicx and the local community, enjoying his evening pint in Barry O'Brien's our local pub, taking part in bucket singing competitions as well as becoming a regular on his guitar at local "sessions" (An informal gathering of musicians, usually held in a pub!). Enjoying the sights, scenery and community that West Cork has to offer.

We wish him well with the completion of his degree and his future and would be delighted to see him back at Ceramicx at some stage in the future.

Talk to us today about your infrared heating needs.

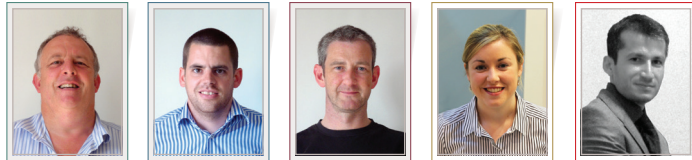

- Frank Wilson *Managing Director* frank.wilson@ceramicx.com
- Dr. Cáthál Wilson *Director* cathal.wilson@ceramicx.co.uk
- Tadhg Whooley *Technical Sales Manager* tadhg.whooley@ceramicx.com
- Amanda Murphy *Sales and Logistics* amanda.murphy@ceramicx.com
- Hasan Duman *Sales - Turkey* hasan.duman@ceramicx.com



Ceramicx Ltd. Gortnagrough, Ballydehob, Co. Cork, Ireland.
Tel: +353 28 37510 Fax: +353 28 37509 Email: sales@ceramicx.com www.ceramicx.com



Ceramicx Ltd. 20 Station Road, Cambridge, CB1 2DJ, U.K.
Tel: +44 1223 653159 Email: sales@ceramicx.co.uk www.ceramicx.co.uk



Ceramicx Ltd. Ikitelli OSB Giyim Sanatkarlari Is ve Tic. Mrk. 3.Ada A Blok No:102 Basaksehir
Istanbul-TURKEY
Tel: +90 212 549 4839 Mobile:+90 544 237 2649 Email: hasan.duman@ceramicx.com www.ceramicx.com



Distributor: **Friedr. Freek GmbH**
Address: Sudetenstraße 9, 58708 Menden, Germany
Tel: +49 23 73 - 95 90-0
Fax: +49 2373 9590-30
Email: mail@freek.de



- Stefan Düellmann *Technical Sales* s.duellmann@freek.de
- Mareike Blak *Sales and marketing* m.blak@freek.de



Distributor: **GSAE**
Address: Room 343 Building A, Business Centre #15, Wangyuan Road, Tianhe District, Guangzhou 510665, China
Tel: 020 22820381 / 020 22820382
Fax: 020 22820383
Email: sales@ceramicx.com.cn



- Pingqiang Li *Managing Director* ceramicx123@gmail.com
- Xu Shan *International Business Engineer* weiwei0604@gmail.com

Exhibitions

- **PastIndia 2015** 9th International plastic exhibition and conference. Gandhinagar, Gujrat, India 5-10 Feb 2015
- **JEC Europe 2015** Composites show and conferences Porte de Versailles, Paris, France 10-12 March, 2015
- **NPE 2015** The International Plastics Showcase. Orlando, Florida, USA. 23 - 27 March 2015

- Exhibiting
- Distributor exhibiting
- Visiting

Ceramicx welcomes new Staff

Ceramicx would like to welcome **Renata Cogan, Tracey Derwin, Dr. Zhe Li** and **Hasan Duman** who have all joined the team at Ceramicx over the last few months.

Tracey joins Gráinne, Amanda and Siobhán in the front office as part of the administration team.

Renata joins Patrick and Pádraig on the production administration team.

Dr. Zhe Li will become responsible for administering the Chinese market as well as supplementing the R&D team and other project undertakings across the plant and business.

Hasan Duman is the founding manager of the Ceramicx office in Istanbul Turkey and will be responsible running this office and for growing Ceramicx sales in the Turkish market.

We would also like to take the opportunity to welcome back **Kitty O'Mahony**. When Infrared International was originally formed Kitty was one of the first employees taken on. Infrared International went on to become Ceramicx and Kitty was here during Ceramicx's foundation, and she has recently rejoined our team bringing a wealth of experience.

Congratulations

The Ceramicx team would like to congratulate...

Stephen Malone and his wife Johanna, on the recent arrival of their baby boy **Jimmy**.

Vincent Goggin and his wife Mags on the birth of their daughter **Lauren Rose**.

and

Tatjana Kudrjasova and her husband Giuven on the birth of their son **Akhim**.

The Ceramicx team would like to extend their congratulations to Patrick Wilson and Jean Lynham on their engagement and wedding later in the year.



www.wecointernational.com

Distributor: **Weco International, Inc.**
 Address: 901 Tacoma Ct. Clio, MI 48420
 Tel: 810 - 686 - 7221, Toll Free: 1-855-IR-2-HEAT
 Fax: 810 - 686 - 7564
 Email: weco@wecointernational.com



■ Brett Wehner
 President/CEO
 brettw@wecointernational.com
 ■ Ted Rosingana
 VP / Technical Sales
 ted@wecointernational.com



www.nippon-heater.co.jp

Distributor: **Nippon Heater Co., Ltd.**
 Address: 2-13-15, Keihinjima, Ota-ku, Tokyo, Japan.
 Tel: +81 3 3790 3111
 Fax: +81 3 3790 1711
 Email: sales@nippon-heater.co.jp



■ Koshiba Tomonobu
 President
 t-koshiba@nippon-heater.co.jp
 ■ Hashimoto Atsushi
 Sales
 a-hashimoto@nippon-heater.co.jp



www.elmec.in

Distributor: **Elmec Heaters and Appliances**
 Address: #103, SIDCO Industrial Estate, Ekkattuthangal, Chennai - 600032, India.
 Tel: 0091 - 44 - 22250313 / 22253566
 Mobile: 0091 928 222 7071
 Email: info@elmec.in



■ Mr. Sundarraj
 elmec.sundar@gmail.com
 ■ Mr. Selvaraj



Abso Industries cc

Distributor: **Abso Industries cc**
 Address: Unit 9, The Square, Prime Park, Printers Way, Montague Gardens, 7447 Cape Town, South Africa.
 Tel: +27 21 552 7303
 Fax: +27 21 552 7304



■ Bobby Bell
 Managing Director
 bobby@absoheating.co.za
 ■ Marc Johnson
 Operations Manager



SMS Resistências Elétricas

www.smsresistencias.com.br

Distributor: **SMS Resistências Elétricas Ltda.**
 Address: Rua do Alumínio, 500 - Parque Sao Pedro Itaquaquecetuba, SP-08586-220, Brazil.
 Tel: +55 11 2211-1088
 Fax: +55-11-4646-1083
 Email: andre.santos@smsresistencias.com.br



■ Andre Santos
 Sales Manager
 andre.santos@smsresistencias.com.br
 ■ Juliana Santos
 Supply Manager
 juliana.santos@smsresistencias.com.br

www.ceramicx.com | www.ceramicx.co.uk

CHECKOUT

ceramicx onlineshop

Infrared heating elements direct from the manufacturer

Ceramic Elements

Trough elements

Hollow Elements

Flat Elements

Ceramic Bulbs

Thermocouples

Quartz Elements

Quartz Heaters

Single Tube Quartz Heaters

Pillared Quartz Heaters

Quartz Tungsten / Halogen Elements

Quartz Tungsten Tubes

Quartz Halogen Tubes

Special Tube Orders

Steatite Press Components



UK

high temperature connectors



IRL

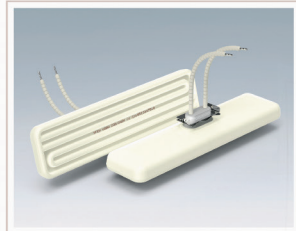

FULL FLAT ELEMENT HOL...

Available from 250 to 800 Watts
Dimensions: 245 x 60 ...

[VIEW PRODUCT](#)



FULL
Avr



HOME > CERAMIC ELEMENTS > HOLLOW ELEMENTS > FULL FLAT HOLLOW INFRARED HEATING CERAMIC ELEMENT | IR

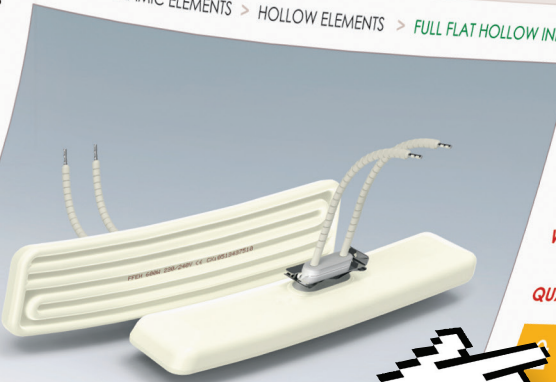

Full Flat Element Hollow
Available from 150 to 800 Watts D

PRICE

COLOUR

WATTAGE

QUANTITY +-

[ADD TO CART](#)

[ADD TO WISH](#)

RELATED PRODUCTS

shoponline



UK www.ceramicx.co.uk



IRL www.ceramicx.com

For all non standard items contact sales@ceramicx.com



ONLINE INFRARED TRAINING COURSE

The course is divided into four modules that set out the basics of Infrared from an Industry perspective.

Each module will take 60-90 minutes to complete and finishes with a short online test. The modules can be taken online, or taught as part of a classroom course.

Further information can be found inside on pages 8 and 9.

The course is now available online at

www.ceramicx.com/applications-training/

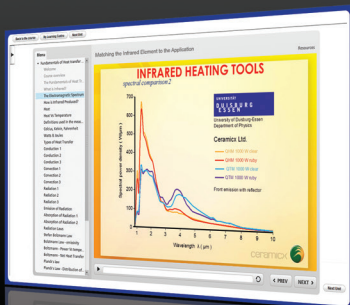

Module 1
Fundamentals of Heat Transfer and Infrared

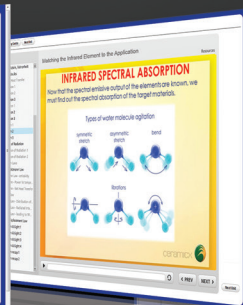

Module 2
Infrared Energy in Process Heat

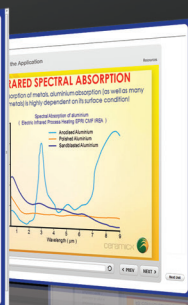

Module 3
Matching the Infrared Element to the Application



Module 4
Control of Infrared